



**Orthopedics**

## Orthopedics

1

**Knee**

2

**Shoulder**

3

**Hip**

4

**Elbow / Foot**

5

**Hand / Fingers / Toes**

6

**FLUID MANAGEMENT Suction and Irrigation Pumps**

7

**Universal Motor Systems**



# Knee

## Knee

|     |   |
|-----|---|
| 1.1 | Standard Equipment                              |
| 1.2 | Meniscal and Soft Tissue Resection / Extraction |
| 1.3 | Meniscus Refixation                             |
| 1.4 | Treatment of Cartilage Defects                  |
| 1.5 | Cruciate Ligament Reconstruction                |
| 1.6 | Leg Holders                                     |

# Basic Equipment

for diagnostic and operative arthroscopy

| Product  | Product no.       | Quantity | Catalog / Section                                      |
|--|-------------------|----------|--|
| <b>Endoscopes and Instruments</b>                            |                   |          |  |
| PANOVIEW telescope 30° Ø 4mm SL 170mm                        | <b>8880.543</b>   | 1        | Orthopedics / Knee                                     |
| Sheath for arthroscope OD 6mm                                | <b>89121.1260</b> | 1        | Orthopedics / Knee                                     |
| Obturator for arthroscope OD 5.5/6/6.3mm                     | <b>89121.0542</b> | 1        | Orthopedics / Knee                                     |
| Fiber light cable bndl, Ø 3.5 mm, 2.3 m long                 | <b>806635231</b>  | 1        | Orthopedics / Knee                                     |
| Hook probe WL 115mm H 4.5mm                                  | <b>8399.95</b>    | 1        | Orthopedics / Knee                                     |
| ARTHROline punch W 4.6mm H 1.6mm, straight sheath            | <b>89140.0102</b> | 1        | Orthopedics / Knee                                     |
| ARTHROline punch W 5.5mm H 1.6mm, sheath curved to the left  | <b>89140.0101</b> | 1        | Orthopedics / Knee                                     |
| ARTHROline punch W 5.5mm H 1.6mm, sheath curved to the right | <b>89140.0103</b> | 1        | Orthopedics / Knee                                     |
| ARTHROline hook punch W 3mm H 1.6mm, straight sheath         | <b>89140.0202</b> | 1        | Orthopedics / Knee                                     |
| Grasping forceps Ø 3.4mm                                     | <b>8488.096</b>   | 1        | Orthopedics / Knee                                     |
| Meniscus grasping forceps Ø 4/7mm                            | <b>8403.001</b>   | 1        | Orthopedics / Knee                                     |
| <b>Treatment of Cartilage Defects – Microfracture</b>        |                   |          |  |
| Curette, round, Ø 4.5mm WL 95mm                              | <b>8435.902</b>   | 1        | Orthopedics / Knee                                     |
| Curette, round, Ø 6mm WL 95mm                                | <b>8435.903</b>   | 1        | Orthopedics / Knee                                     |
| Microfractor WL 170mm 15°                                    | <b>891631521</b>  | 1        | Orthopedics / Knee                                     |
| Microfractor WL 170mm 30°                                    | <b>891633021</b>  | 1        | Orthopedics / Knee                                     |
| Microfractor WL 170mm 35°                                    | <b>891633522</b>  | 1        | Orthopedics / Knee                                     |
| Microfractor WL 170mm 45°                                    | <b>891634521</b>  | 1        | Orthopedics / Knee                                     |
| Microfractor WL 170mm 60°                                    | <b>891636021</b>  | 1        | Orthopedics / Knee                                     |
| <b>Shaver Set</b>  |                   |          |  |
| PowerSpeed AS1 MOTOR CONTROL UNIT 2305                       | <b>2305001</b>    | 1        | Orthopedics / Motor Systems                            |
| Remote footswitch 2 pedals+2 buttons                         | <b>2305100</b>    | 1        | Orthopedics / Motor Systems                            |
| Motor handpiece max. 16000rpm                                | <b>8995500031</b> | 1        | Orthopedics / Motor Systems                            |
| Resector toothed Ø 4.5mm                                     | <b>89975.0034</b> | 1        | Orthopedics / Motor Systems                            |
| Resector oval, Ø 4.5mm                                       | <b>89975.0114</b> | 1        | Orthopedics / Motor Systems                            |
| Resector aggress Ø 4.7mm                                     | <b>89975.0334</b> | 1        | Orthopedics / Motor Systems                            |
| Acromionizer Ø 5.5mm   | <b>89975.0555</b> | 1        | Orthopedics / Motor Systems                            |
| <b>Fluid Management</b>                                      |                   |          |  |
| FLUID CONTROL arthro/spine suc./irrig.pump bndl              | <b>22040011</b>   | 1        | Orthopedics / FLUID CONTROL<br>Suction irrigation pump |
| Irrigation tube set spike L 3m                               | <b>4171223</b>    | 1        |  |
| <b>Imaging</b>   |                   |          |  |
| ENDOCAM Logic HD Camera Controller bndl                      | <b>55251051</b>   | 1        | Imaging / ENDOCAM                                      |
| ENDOCAM Logic HD camera head cable 3 m                       | <b>85525922</b>   | 1        | Imaging / ENDOCAM                                      |
| RIWO zoom lens F 13–29mm                                     | <b>85261504</b>   | 1        | Imaging / ENDOCAM                                      |
| Light source LED 2.2 bndl                                    | <b>51640011</b>   | 1        | Imaging / Light Sources                                |
| Light source LED 1.1 bndl                                    | <b>51600011</b>   | 1        | Imaging / Light Sources                                |
| LCD monitor 27" 4K   | <b>LMD-X2705N</b> | 1        | Imaging / Monitors                                     |
| Monitor mount VESA 75/100                                    | <b>321165001</b>  | 1        | Imaging / Device Carts                                 |

**arthro** *lution* Arthroscope

Overview

Knee  
1.1

| arthro <i>lution</i>    |  |                               | Fingers, toes    | Hand             | Foot, elbow      |                  | Knee, shoulder, hip |
|-------------------------|--|-------------------------------|------------------|------------------|------------------|------------------|---------------------|
| Telescope Ø             |  |                               | 1.9 mm           | 2.4 mm           | 2.7 mm           |                  | 4.0 mm              |
| Telescopes              | 30°  | PANOVIEW telescope            | <b>8860453</b>   | <b>8871413</b>   | <b>8476.433</b>  | <b>8672.422</b>  | <b>8880.543</b>     |
|                         |  | PANOVIEW wide angle telescope |                  |                  |                  |                  | <b>8885.443</b>     |
|                         | 70°  | PANOVIEW telescope            |                  |                  |                  |                  | <b>8880.545</b>     |
|                         |  | PANOVIEW wide angle telescope |                  |                  |                  |                  | <b>8885.445</b>     |
| Sheath WL               |  |                               | 40 mm            | 60 mm            | 77.5 mm          | 145 mm           | 130 mm              |
| Sheaths                 | with 1 irrigation stopcock, fixed                    |                               | <b>891220124</b> | <b>891220132</b> |                  |                  |                     |
|                         | with 2 irrigation stopcocks, fixed                   |                               |                  |                  |                  |                  | <b>89121.0260</b>   |
|                         | with 1 irrigation stopcock, rotatable                |                               |                  |                  |                  | <b>891241141</b> |                     |
|                         | with 2 irrigation stopcocks, rotatable               |                               |                  | <b>891221232</b> | <b>891221241</b> | <b>891241241</b> | <b>89121.1260</b>   |
|                         | High-Flow with 1 irrigation stopcock, fixed          |                               | <b>891220128</b> |                  |                  |                  |                     |
|                         | High-Flow with 2 irrigation stopcocks, rotatable     |                               |                  | <b>891221235</b> |                  |                  | <b>89121.1263</b>   |
|                         | Small-caliber with 2 irrigation stopcocks, rotatable |                               |                  |                  |                  |                  | <b>891221255</b>    |
| Obturator               | blunt  |                               |                  |                  | <b>891222754</b> |                  | <b>89121.0544</b>   |
|                         | semi-blunt   |                               | <b>891221952</b> | <b>891222452</b> |                  |                  | <b>89121.0542</b>   |
|                         | conical blunt  |                               |                  |                  | <b>891222750</b> | <b>891242750</b> | <b>89121.0540</b>   |
|                         | sharp  |                               |                  |                  |                  | <b>891242761</b> | <b>89121.0640</b>   |
|                         | conical pointed                                      |                               | <b>891221962</b> | <b>891222462</b> | <b>891222762</b> |                  |                     |
| Sealing part for sheath |  |                               |                  |                  |                  | <b>891040000</b> |                     |

|| Subject to modifications. Please note that some products may not be available in all countries. For more detailed information, please consult with your contact partner or directly with Richard Wolf GmbH.

# Arthroscope with PANOVIEW Telescope Ø 4 mm

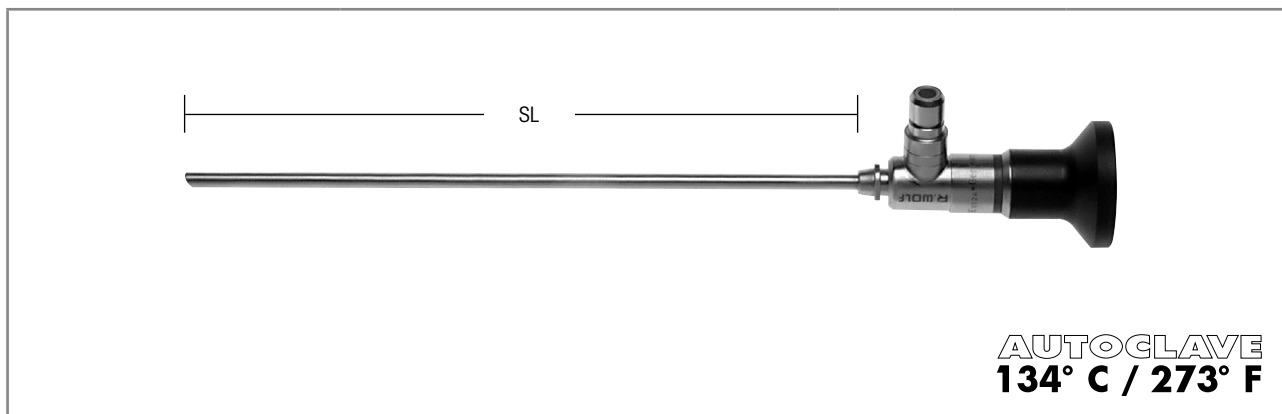

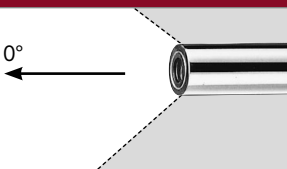
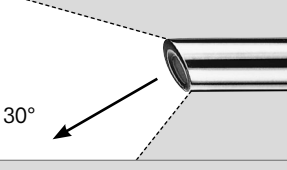
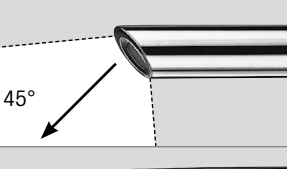
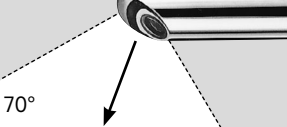
| Direction of view  |  | SL     | Ø      | Product no.     |
|--|--|--------|--------|-----------------|
|  <p>0°</p>   | PANOVIEW<br>telescope 0° Ø 4mm SL 170mm  | 170 mm | 4.0 mm | <b>8880.541</b> |
|  <p>30°</p> | PANOVIEW<br>telescope 30° Ø 4mm SL 170mm |        |        | <b>8880.543</b> |
|  <p>45°</p> | PANOVIEW<br>telescope 45° Ø 4mm SL 170mm |        |        | <b>8880.544</b> |
|  <p>70°</p> | PANOVIEW<br>telescope 70° Ø 4mm SL 176mm | 176 mm |        | <b>8880.545</b> |

| Recommended accessories   |                              | Product no.      |
|---|------------------------------|------------------|
| <b>Perf. basket for standard telescope 1</b>  | (L x B x H) 297 x 59 x 54 mm | <b>38015</b>     |
| <b>Fiber light cable bndl</b><br>Comprising:<br>Fiber light cable (80663523),<br>adapter, projector to light cable (8095.07), and<br>adapter, light cable to endoscope (809509) | Ø 3.5 mm, 2.3 m long         | <b>806635231</b> |

# Arthroscope with PANOVIEW Wide Angle Telescope

Knee

1.1

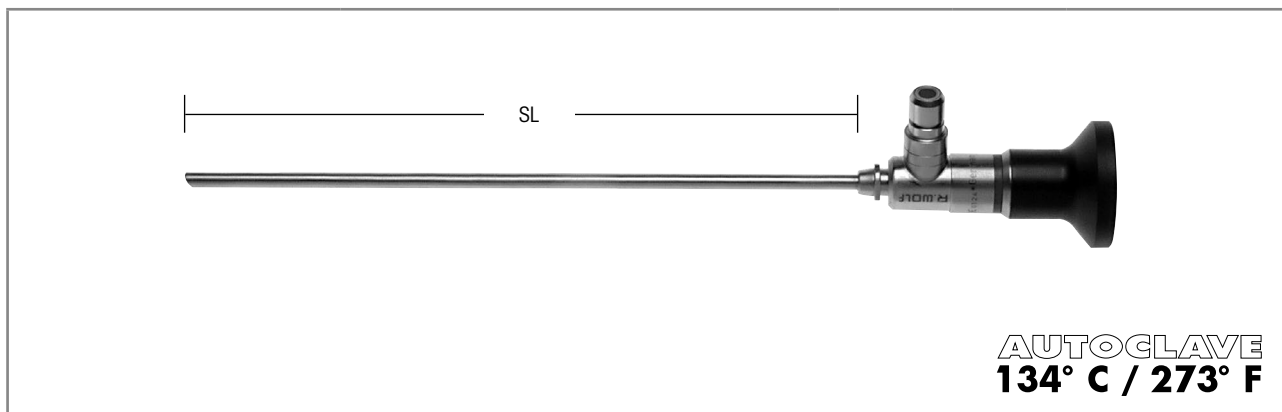

**AUTOCLAVE**  
**134° C / 273° F**

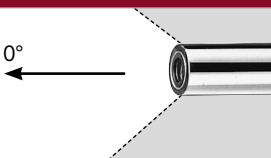
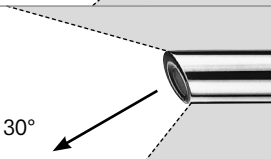
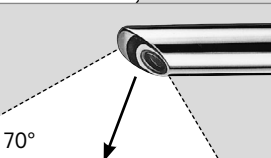

| Direction of view  |   | SL     | Ø      | Product no.     |
|--|---|--------|--------|-----------------|
|  <p>0°</p>   | <p>PANOVIEW<br/>Wide angle telescope 0° Ø 4mm SL 171mm</p>  | 171 mm | 4.0 mm | <b>8885.441</b> |
|  <p>30°</p> | <p>PANOVIEW<br/>Wide angle telescope 30° Ø 4mm SL 170mm</p> | 170 mm |        | <b>8885.443</b> |
|  <p>70°</p> | <p>PANOVIEW<br/>Wide angle telescope 70° Ø 4mm SL 176mm</p> | 176 mm |        | <b>8885.445</b> |

| Recommended accessories   |                              | Product no.      |
|---|------------------------------|------------------|
| <b>Perf. basket for standard telescope 1</b>  | (L x B x H) 297 x 59 x 54 mm | <b>38015</b>     |
| <b>Fiber light cable bndl</b><br>Comprising:<br>Fiber light cable (80663523),<br>adapter, projector to light cable (8095.07), and<br>adapter, light cable to endoscope (809509) | Ø 3.5 mm, 2.3 m long         | <b>806635231</b> |

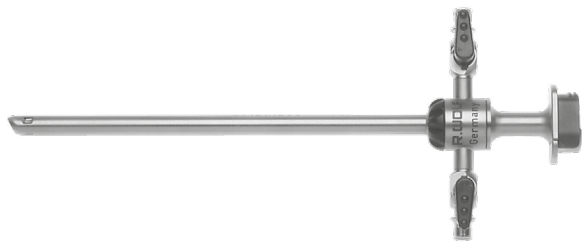

# arthro<sup>lution</sup> Sheath for Arthroscope

with automatic click-lock mechanism

|  |               |                   |                       |         |        |                   |  |   |  |   |
|---|---------------|-------------------|-----------------------|---------|--------|-------------------|--|---|--|---|
| <b>Sheath for arthroscope OD 6mm</b>  |               |                   |                       |         |        |                   | <b>Obturator for arthroscope 5.5/6/6.3mm blunt</b>                                 | <b>Obturator for arthroscope 5.5/6/6.3mm semi-blunt</b> | <b>Obturator for arthroscope 5.5/6/6.3mm conical blunt</b> | <b>Trocar tip, triangular SZ 4mm WL 176mm</b> |
| High-Flow   | Small-caliber | 2 fixed stopcocks | 2 rotatable stopcocks | Outer Ø | WL     | Product no.       |  |   |  |   |
|   |               | ●                 |                       | 6.0 mm  | 132 mm | <b>89121.0260</b> | <b>89121.0544</b>  | <b>89121.0542</b>                                       | <b>89121.0540</b>  | <b>89121.0640</b>                             |
|   |               |                   | ●                     | 6.0 mm  | 130 mm | <b>89121.1260</b> |  |   |  |   |
| ●   |               |                   | ●                     | 6.3 mm  | 130 mm | <b>89121.1263</b> |  |   |  |   |
|   | ●             |                   | ●                     | 5.5 mm  | 130 mm | <b>891221255</b>  |  |   |  |   |





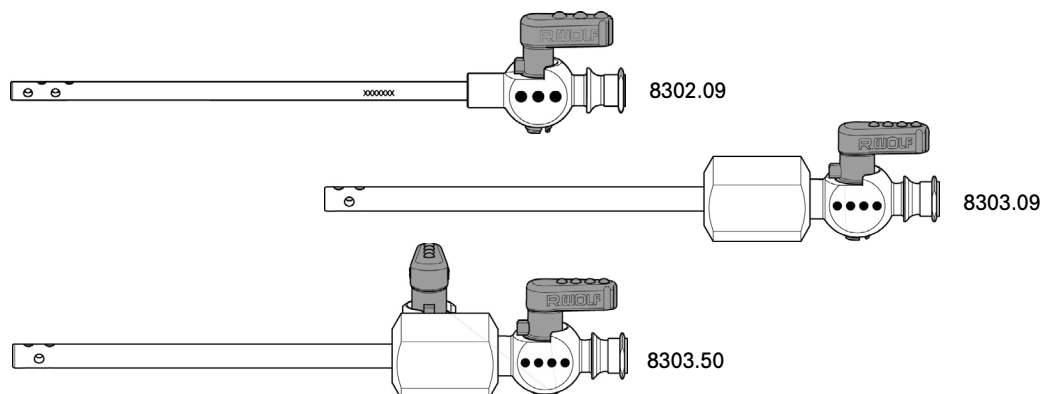

| Spare parts   | Product no.                          |
|---|--------------------------------------|
| Irrigation ring with 1 stopcock   | <b>150081761</b>                     |
| Irrigation ring with 2 stopcocks  | <b>150081762</b>                     |
| Stopcock insert, bundle, cap 3.0mm (PACK= 5 PCS)<br>Also: Disassembly tool                          | <b>896.0002</b><br><b>38310.0001</b> |
| Mounting ring   | <b>15008.1704</b>                    |
| Spare sealing comprising: O-rings, small / large, 5 of each<br>Also: O-ring tool (disassembly tool) | <b>15176.142</b><br><b>15106.230</b> |

| Recommended accessories                        | Product no.       |
|--|-------------------|
| Sealing part for sheath                        | <b>89101.0000</b> |
| Marking rod Ø 4.0mm<br>conical blunt TL 325 mm | <b>8863.75</b>    |

VI121 || Subject to modifications. Please note that some products may not be available in all countries. For more detailed information, please consult with your contact partner or directly with Richard Wolf GmbH.

# Drainage Cannula Ø 2.3 mm / 3.7 mm

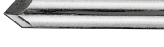

| Drainage for cannula and obturator  |   | Capacity | Ø            | WL      | Product no.     |
|---|---|----------|--------------|---------|-----------------|
| <b>Drainage for cannula Ø 3.2 mm</b><br>WL 80 mm<br>with 1 insufflation stopcock    |  | 2.3 mm   | 3.2 mm       | 80 mm   | <b>8302.09</b>  |
| <b>Drainage for cannula Ø 4.5 mm</b><br>WL 71.5 mm<br>with 1 insufflation stopcock  |  | 3.7 mm   | 4.5 mm       | 71.5 mm | <b>8303.09</b>  |
| <b>Drainage for cannula Ø 4.5 mm</b><br>WL 71.5 mm<br>with 2 insufflation stopcocks |  | 3.7 mm   | 4.5 mm       | 71.5 mm | <b>8303.50</b>  |
| <b>Obturator for cannula OD 3.2 mm</b><br>sharp, with slanted tip                   |  | -        | 2.3 mm       | 103 mm  | <b>8302.101</b> |
| <b>Obturator for cannula OD 3.2 mm</b><br>conical blunt tip                         |  | -        | 2.3 mm       | 103 mm  | <b>8302.11</b>  |
| <b>Obturator for cannula OD 4.5 mm</b><br>sharp, with pyramid-shaped tip            |  | -        | 4.5 mm       | 115 mm  | <b>8303.10</b>  |
| <b>Obturator for cannula OD 4.4 mm</b><br>conical blunt tip                         |  | -        | 4.4 mm       | 115 mm  | <b>8303.11</b>  |
| Also:   |   |          |              |         |                 |
| <b>Silicone tube</b><br>with Luer fitting 886.00                                    | for Drainage for cannula<br>8302.09   |          | Length 2.0 m |         | <b>8302.90</b>  |
| <b>Silicone tube</b><br>with Luer fitting 886.01                                    | for Drainage for cannula<br>8303.09 / 50  |          |              |         | <b>8303.90</b>  |

VII21 || Subject to modifications. Please note that some products may not be available in all countries. For more detailed information, please consult with your contact partner or directly with Richard Wolf GmbH.

## Hook Probe / Marking Rod



|   | H      | WL     | Product no.     |
|---|--------|--------|-----------------|
| <b>Hook probe WL 115mm H 7mm, graduated</b><br>    | 7.0 mm | 115 mm | <b>8399.901</b> |
| <b>Hook probe WL 115mm H 4.5mm, graduated</b><br> | 4.5 mm |        | <b>8399.95</b>  |



|   | Ø      | TL     | Product no.    |
|---|--------|--------|----------------|
| <b>Hook probe TL 228 mm SZ 4.4mm</b><br> | 4.4 mm | 228 mm | <b>8863.80</b> |





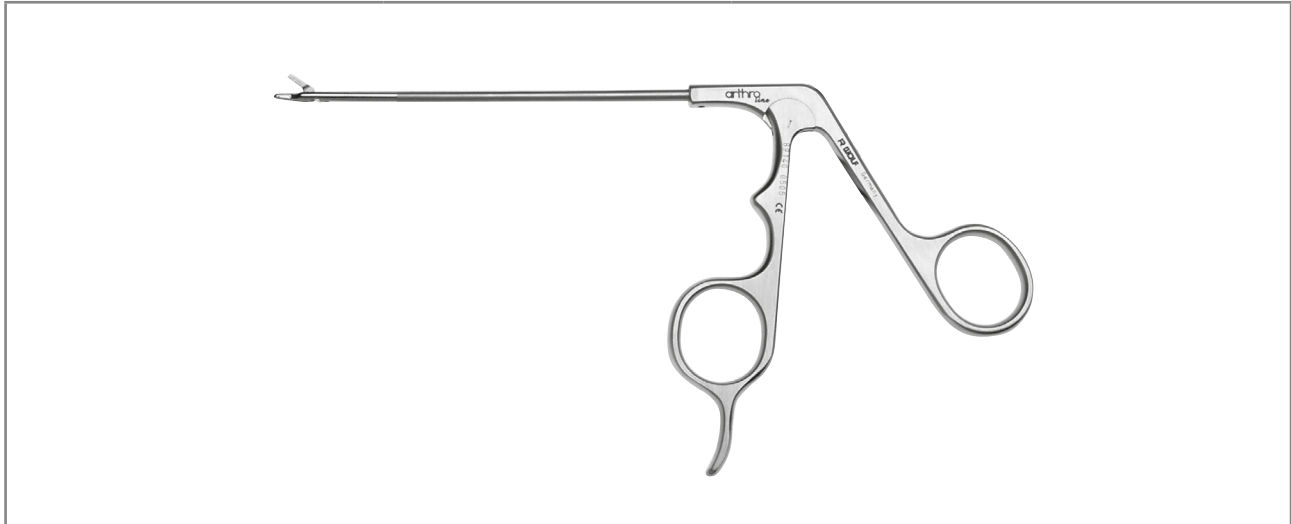

|   | Ø      | TL     | Product no.    |
|---|--------|--------|----------------|
| <b>Marking rod Ø 4.0mm conical blunt</b><br> | 4.0 mm | 325 mm | <b>8863.75</b> |

**arthro**  
*line* Punch

Versions









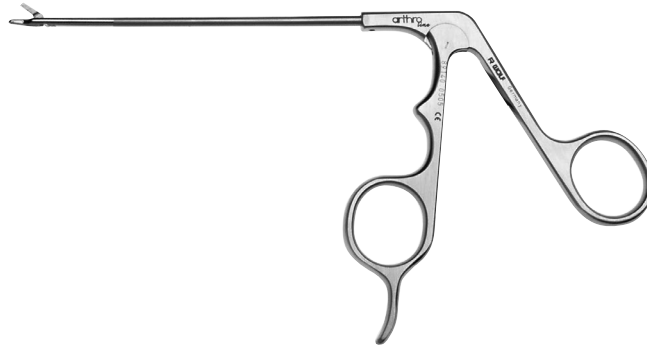



| Version   |                                 | Use  |
|---|---------------------------------|--|
|  | <b>Straight</b>                 | For direct access                                    |
|  | <b>Jaws curved 15° upward</b>   | Facilitates use,<br>e.g., around the posterior horn  |
|  | <b>Sheath curved 15° upward</b> | Tailored to the anatomy of the condyles              |
|  | <b>Curved to the left</b>       | Better access to the anterior and posterior meniscus |
|  | <b>Curved to the right</b>      |  |

Knee  
1.2

arthroline Punch











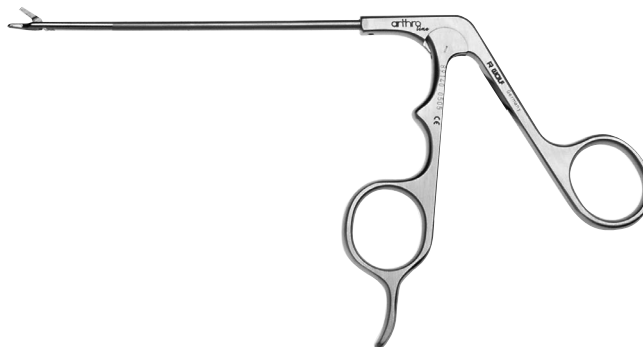



| ARTHROline   | Jaw section (Height x width) | Cut width | WL     | Straight | Curved to the right | Curved to the left | Sheath curved upward | Jaw section curved upward | Product no. |            |            |
|--|------------------------------|-----------|--------|----------|---------------------|--------------------|----------------------|---------------------------|-------------|------------|------------|
| <b>Punch W 4.6mm H 1.6mm</b><br>movable jaw section serrated<br><br>Sectional view:  | 1.6 x 4.6 mm                 | 3.3 mm    | 120 mm | ●        |                     |                    |                      |                           | 89140.0105  |            |            |
| <b>Punch W 4.6mm H 1.6mm</b><br>movable jaw section serrated<br><br>Sectional view:  |                              |           |        |          |                     |                    |                      | ●                         | 89140.0102  |            |            |
| <b>Punch W 4. mm H 1.6mm</b><br>movable jaw section serrated<br><br>Sectional view:  |                              |           |        |          |                     |                    |                      |                           | ●           | 89140.0122 |            |
| <b>Punch W 5.5mm H 1.6mm</b><br>movable jaw section serrated<br><br>Sectional view:  |                              |           |        |          |                     |                    |                      | ●                         |             | ●          | 89140.0101 |
| <b>Punch W 5.5mm H 1.6mm</b><br>movable jaw section serrated<br><br>Sectional view:  |                              |           |        |          |                     |                    | ●                    |                           |             |            | ●          |

VI121 || Subject to modifications. Please note that some products may not be available in all countries. For more detailed information, please consult with your contact partner or directly with Richard Wolf GmbH.

arthroline Hook Punch / Basket Punch

Knee  
1.2









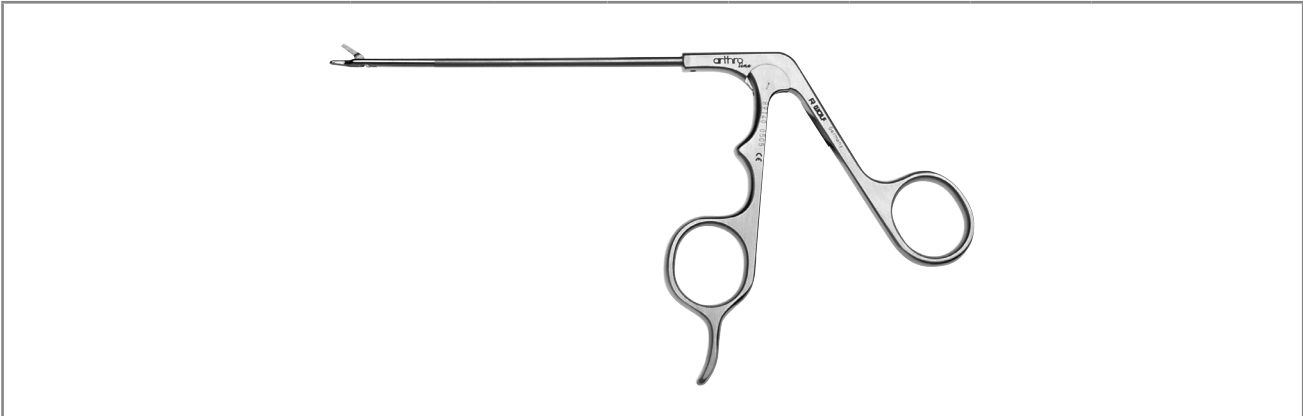

| ARTHROline   | Jaw section (Height x width) | Cut width | WL     | Straight | Jaw section curved upward | Product no.       |
|--|------------------------------|-----------|--------|----------|---------------------------|-------------------|
| <b>Hook punch W 3mm H 1.6mm</b><br><br>Sectional view:           | 1.6 x 3.0 mm                 | 1.8 mm    | 120 mm | ●        |                           | <b>89140.0205</b> |
| <b>Hook punch W 3mm H 1.6mm</b><br><br>Sectional view:           |                              |           |        | ●        |                           | <b>89140.0202</b> |
| <b>Basket punch W 6.5mm H 2.1mm oval</b><br><br>Sectional view:  | 2.1 x 6.5 mm                 | 4.5 mm    |        | ●        |                           | <b>89140.0305</b> |
| <b>Basket punch W 6.5mm H 2.1mm oval</b><br><br>Sectional view:  |                              |           |        | ●        |                           | <b>89140.0302</b> |
| <b>Hook punch W 4mm H 2.1mm</b><br><br>Sectional view:           | 2.1 x 4.0 mm                 | 2.1 mm    |        | ●        |                           | <b>89140.0405</b> |
| <b>Hook punch W 4 mm H 2.1mm</b><br><br>Sectional view:          |                              |           |        | ●        |                           | <b>89140.0402</b> |

VI/21 || Subject to modifications. Please note that some products may not be available in all countries. For more detailed information, please consult with your contact partner or directly with Richard Wolf GmbH.

**arthro**  
*line* Punch / Scissors Punch





| ARTHROline  | Jaw section (Height x width) | Cut width | WL     | Straight | Retrograde cutting | Jaw section curved upward | Product no.       |
|---|------------------------------|-----------|--------|----------|--------------------|---------------------------|-------------------|
| <b>Scissors punch W 2.4mm H 2.1 mm</b><br><br>Sectional view:               | 2.1 x 2.4 mm                 | 0.9 mm    | 120 mm | ●        |                    |                           | <b>89140.0505</b> |
| <b>Scissors punch W 2.4mm H 2.1 mm</b><br><br>Sectional view:               |                              |           |        |          | ●                  |                           | <b>89140.0502</b> |
| <b>Punch W 5.7mm H 4mm retrograde left-cutting</b><br><br>Sectional view:   | 4.0 x 5.7 mm                 | 2.3 mm    |        | ●        | left               |                           | <b>89140.0605</b> |
| <b>Punch W 5.7mm H 4mm retrograde right-cutting</b><br><br>Sectional view:  |                              |           |        | ●        | right              |                           | <b>89140.0602</b> |

## Suction Punch / Suction Grasping Forceps with Integrated Suction Channel



Knee

1.2

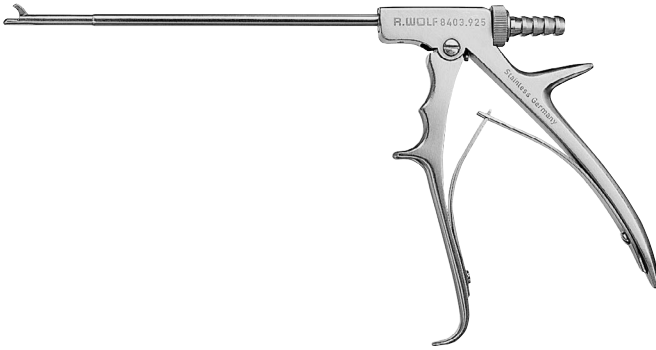

| With integrated suction channel  | Ø      | WL     | Product no.       |
|--|--------|--------|-------------------|
| <b>Suction punch Ø 2.7mm</b><br><br>can be dismantled  | 2.7 mm | 110 mm | <b>89140.0027</b> |
| <b>Suction punch Ø 4.5mm</b><br><br>can be dismantled | 4.5 mm |        | <b>89140.0045</b> |











| With integrated suction channel   | Sheath Ø | WL     | Product no.     |
|---|----------|--------|-----------------|
| <b>Suction punch Ø 4.5mm straight</b><br>    | 4.5 mm   | 130 mm | <b>8403.925</b> |
| <b>Suction grasping forceps straight</b><br> |          |        | <b>8403.851</b> |



## Hook Punch / Punch





|   | Jaw section<br>(Height x<br>width) | Cut<br>width | WL     | Straight | Curved<br>to the<br>left | Curved<br>to the<br>right | Sheath<br>curved<br>15°<br>upward | Jaw<br>section<br>curved<br>upward | Product no. |          |          |
|---|------------------------------------|--------------|--------|----------|--------------------------|---------------------------|-----------------------------------|------------------------------------|-------------|----------|----------|
| <b>Hook punch Ø 3.4mm<br/>with shovel</b>   | 3.4 x 3.4 mm                       | 1.6 mm       | 130 mm | ●        |                          |                           |                                   |                                    | 8488.951    |          |          |
|                  |                                    |              |        |          | ●                        |                           |                                   |                                    |             | 8488.952 |          |
|   |                                    |              |        |          |                          | ●                         |                                   |                                    |             |          | 8488.953 |
| Sectional view:  |                                    |              |        |          |                          |                           |                                   |                                    | ●           | ●        | 8488.954 |
| <b>Hook punch Ø 3.4mm</b>   | 3.4 x 3.4 mm                       | 1.6 mm       |        | ●        |                          |                           |                                   |                                    | 8488.02     |          |          |
|                  |                                    |              |        |          |                          |                           |                                   |                                    | ●           | 8488.025 |          |
| Sectional view:  |                                    |              |        |          |                          |                           |                                   |                                    |             |          |          |
| <b>Hook punch Ø 3.4mm<br/>serrated</b>  | 1.93 x 3.9 mm                      | 2.7 mm       |        | ●        |                          |                           |                                   |                                    | 8488.121    |          |          |
|                  |                                    |              |        |          |                          |                           |                                   |                                    |             | ●        | 8488.063 |
| Sectional view:  |                                    |              |        |          |                          |                           |                                   |                                    |             |          |          |
| <b>Hook punch Ø 4.5mm<br/>with shovel, serrated</b>   | 1.73 x 5.4 mm                      | 3.4 mm       |        |          |                          |                           |                                   | ●                                  | 8489.063    |          |          |
|                  |                                    |              |        |          |                          |                           |                                   |                                    |             |          |          |
| Sectional view:  |                                    |              |        |          |                          |                           |                                   |                                    |             |          |          |

# Punch

Knee





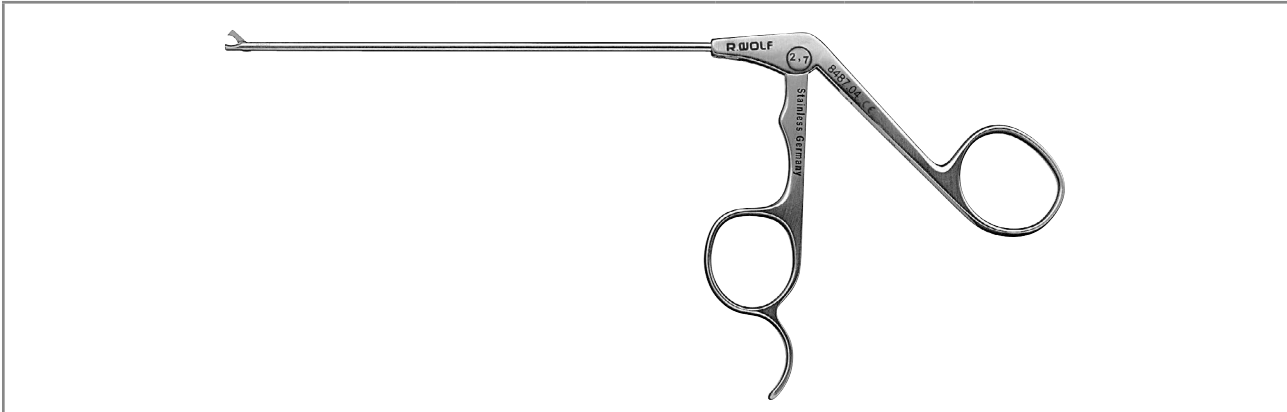

|  | Jaw section<br>(Height x width) | Jaw section<br>deflection | Cut width | WL     | Product no.     |
|--|---------------------------------|---------------------------|-----------|--------|-----------------|
| <b>Punch Ø 3.4mm</b><br>front- and side-cutting<br><br><br>Sectional view: <input type="checkbox"/> | 2.2 x 5.3 mm                    | 90°<br>left               | 3.4 mm    | 130 mm | <b>8404.017</b> |
|  |                                 | 90°<br>right              |           |        | <b>8404.018</b> |
| <b>Hook punch with shovel</b><br>Ø 3.4mm<br><br><br>Sectional view: <input type="checkbox"/>        | 2.1 x 2.0 mm                    | 45°<br>left               | 1.7 mm    |        | <b>8404.71*</b> |
|  |                                 | 45°<br>right              |           |        | <b>8404.81*</b> |

\* particularly suitable for lateral cutting and smoothing

# Scissors



|   | WL     | Straight jaw section   | Straight sheath | Sheath curved to the left | Sheath curved to the right | Product no. |          |
|---|--------|------------------------|-----------------|---------------------------|----------------------------|-------------|----------|
| <b>Hook scissors Ø 2.7mm</b><br>   | 130 mm | ●                      | ●               |                           |                            | 8487.04     |          |
| <b>Hook scissors Ø 3.4mm</b><br>   |        | ●                      | ●               |                           |                            | 8488.04     |          |
| <b>Micro scissors Ø 3.4mm</b><br><br>Sectional view:  |        | ●                      |                 | ●                         |                            | 8488.041    |          |
|   |        | ●                      |                 |                           | ●                          |             | 8488.042 |
|   |        | ●                      | ●               |                           |                            |             | 8488.051 |
|   |        |                        | ●               |                           |                            | ●           | 8488.052 |
|   |        |                        | ●               |                           |                            | ●           | 8488.053 |
|   | WL     | Jaw section deflection | Straight sheath |                           | Product no.                |             |          |
| <b>Hook scissors Ø 3.4mm</b><br>   | 130 mm | 45° left               | ●               |                           | 8404.52                    |             |          |
|   |        | 45° right              | ●               |                           | 8404.62                    |             |          |

VI121 || Subject to modifications. Please note that some products may not be available in all countries. For more detailed information, please consult with your contact partner or directly with Richard Wolf GmbH.

# Forceps

Knee

1.2

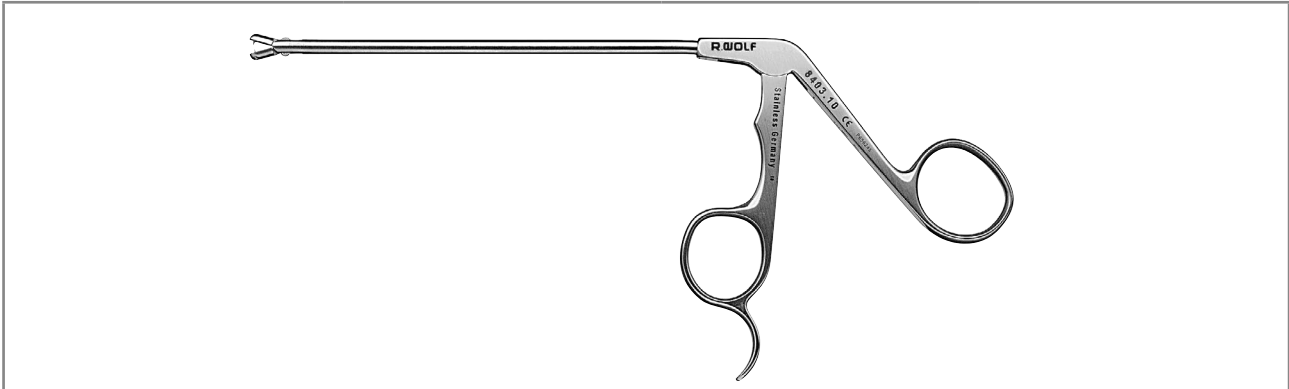

| For retraction  | Ø      | WL     | Product no.    |
|---|--------|--------|----------------|
| <b>Biopsy forceps with spike</b><br><b>Ø 4.5mm</b><br>smooth, double-action | 4.5 mm | 130 mm | <b>8403.10</b> |

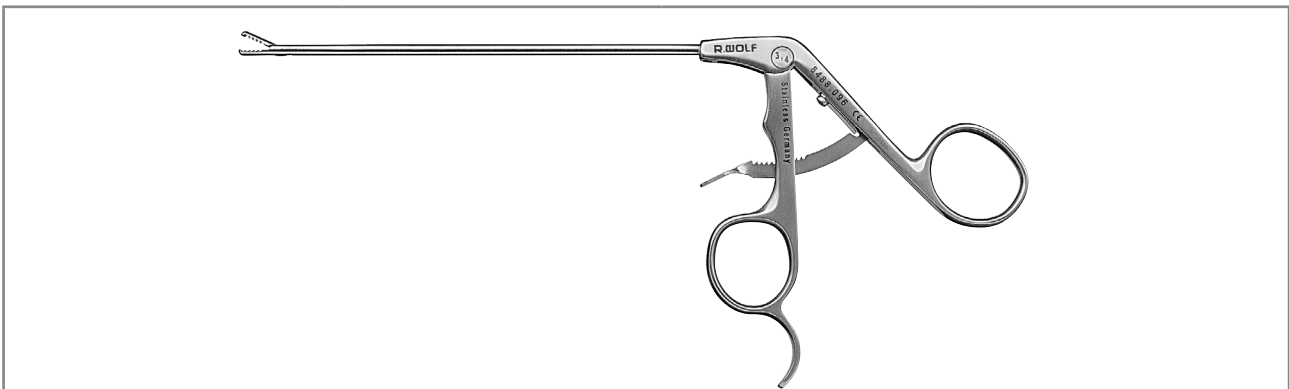

| Handle with lock  | Ø      | WL     | Product no.     |
|---|--------|--------|-----------------|
| <b>Grasping forceps Ø 3.4mm</b><br>straight jaw section, serrated | 3.4 mm | 130 mm | <b>8488.096</b> |
| <b>Grasping forceps Ø 4.5mm</b><br>straight jaw section, serrated | 4.5 mm | 134 mm | <b>8489.096</b> |



## Suture Grasping Forceps / Meniscus Grasping Forceps

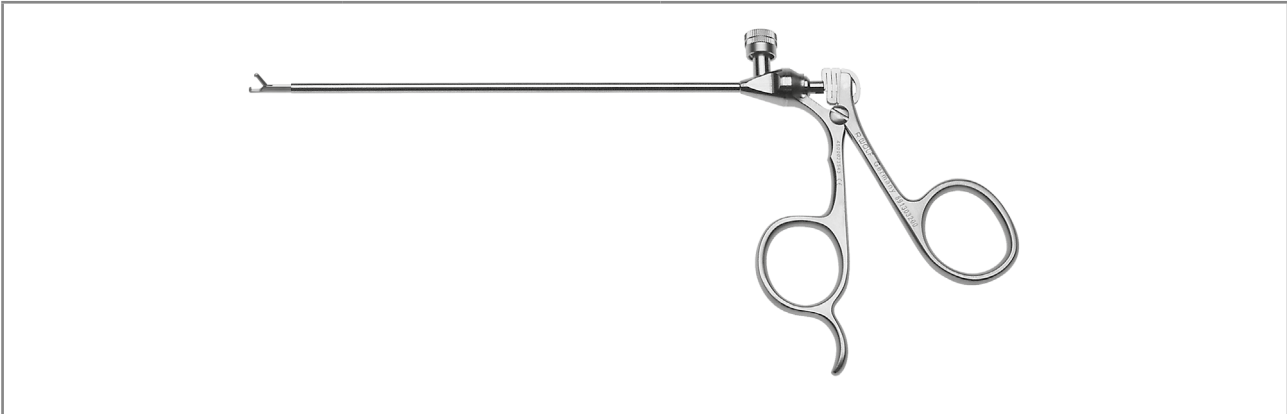

|   | Ø      | WL     | Product no.      |
|---|--------|--------|------------------|
| <b>Suture grasping forceps Ø 3.3mm</b><br>Straight<br> | 3.3 mm | 160 mm | <b>891303300</b> |

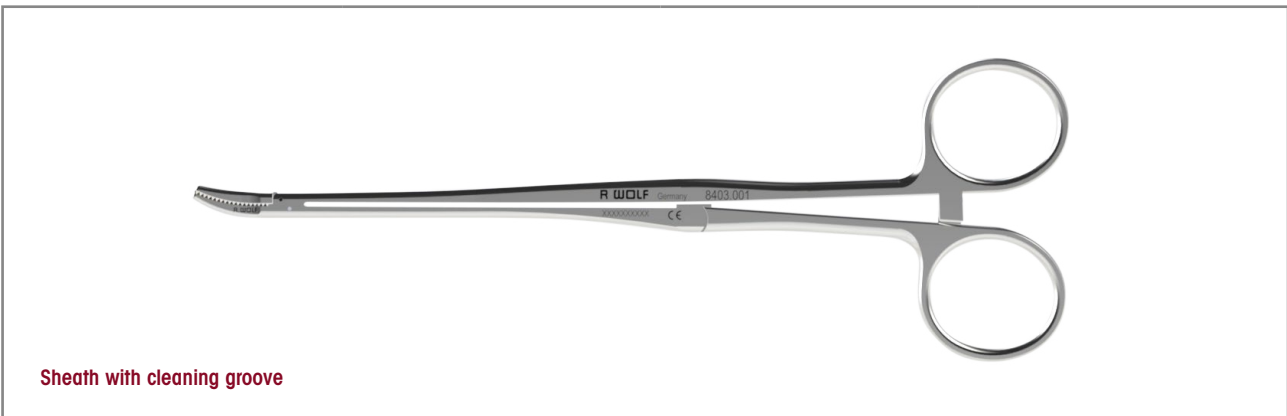





|  | Ø        | WL     | Product no.     |
|--|----------|--------|-----------------|
| <b>Meniscus grasping forceps</b><br><b>Ø 4/7mm</b><br>with gripping tooth<br> | 4 / 7 mm | 105 mm | <b>8403.00</b>  |
| <b>Meniscus grasping forceps</b><br><b>Ø 4/7 mm</b><br>                       |          |        | <b>8403.001</b> |

# Scalpel / Knife



Knee





1.2

|  | WL     | Product no.     |
|--|--------|-----------------|
| <b>Straight scalpel WL 125mm</b><br>      |        | <b>8436.101</b> |
| <b>Rosette knife WL 125mm</b><br>         |        | <b>8436.151</b> |
| <b>Hook knife WL 125mm</b><br>            | 125 mm | <b>8436.201</b> |
| <b>Banana knife WL 125mm</b><br>          |        | <b>8436.251</b> |
| <b>Straight arthro knife WL 125mm</b><br> |        | <b>8436.301</b> |

# Hand Instruments

## Curette







|  | Ø      | WL     | Product no.      |
|--|--------|--------|------------------|
| <br><b>Curette square Ø 4.5mm WL 170mm</b><br><br>double-blade and curved upward | 4.5 mm | 170 mm | <b>891632245</b> |
| <br><b>Curette square Ø 5mm WL 170mm</b><br><br>double-blade and curved upward  | 5.0 mm |        | <b>891632260</b> |
| <br><b>Curette round Ø 4.8mm WL 170mm</b><br><br>double-blade and curved upward | 4.8 mm |        | <b>891631255</b> |
| <br><b>Curette round Ø 6.3mm WL 170mm</b><br><br>double-blade and curved upward | 6.3 mm |        | <b>891631270</b> |

# Hand Instruments

## Curette

Knee

1.3











|  |  | Inner Ø | WL    | Product no.       |
|--|--|---------|-------|-------------------|
| <p><b>Curette, round<br/>Ø 3mm WL 95mm</b></p> <p>sharp at one end,<br/>curved upward,<br/>forward cutting</p>       |  | 3.0 mm  | 95 mm | <b>8435.901</b>   |
| <p><b>Curette, round<br/>Ø 4.5mm WL 95mm</b></p> <p>sharp at one end,<br/>curved upward,<br/>forward cutting</p>    |  | 4.5 mm  |       | <b>8435.902</b>   |
| <p><b>Curette, round<br/>Ø 6mm WL 95mm</b></p> <p>sharp at one end,<br/>and curved upward,<br/>forward cutting</p>  |  | 6.0 mm  |       | <b>8435.903</b>   |
| <p><b>Curette, round<br/>Ø 9mm WL 95mm</b></p> <p>sharp at one end,<br/>and curved upward,<br/>forward cutting</p>  |  | 9.0 mm  |       | <b>89160.1009</b> |



# Hand Instruments

## Microfractor



|   | Deflection   | WL               | Product no.      |
|---|--------------|------------------|------------------|
| <b>Microfractor</b><br>WL 170mm 15°    | Curved 15°   | 170 mm           | <b>891631521</b> |
| <b>Microfractor</b><br>WL 170mm 30°  | Curved 30°   |                  | <b>891633021</b> |
| <b>Microfractor</b><br>WL 170mm 45°  | Curved 45°   |                  | <b>891634521</b> |
| <b>Microfractor</b><br>WL 170mm 35°  | 35° S-shaped |                  | <b>891633522</b> |
| <b>Microfractor</b><br>WL 170mm 60°  | Curved 60°   |                  | <b>891636021</b> |
| <b>Microfractor</b><br>WL 170mm 60°  | 60° S-shaped |                  | <b>891636022</b> |
| <b>Microfractor</b><br>WL 170mm 80°  | Curved 80°   |                  | <b>891638021</b> |
| <b>Microfractor</b><br>WL 65mm 30°   | Curved 30°   |                  | 65 mm            |
| <b>Microfractor</b><br>WL 65mm 45°   | Curved 45°   | <b>891644511</b> |                  |
| <b>Microfractor</b><br>WL 65mm 60°   | Curved 60°   | <b>891646011</b> |                  |

VI121 || Subject to modifications. Please note that some products may not be available in all countries. For more detailed information, please consult with your contact partner or directly with Richard Wolf GmbH.



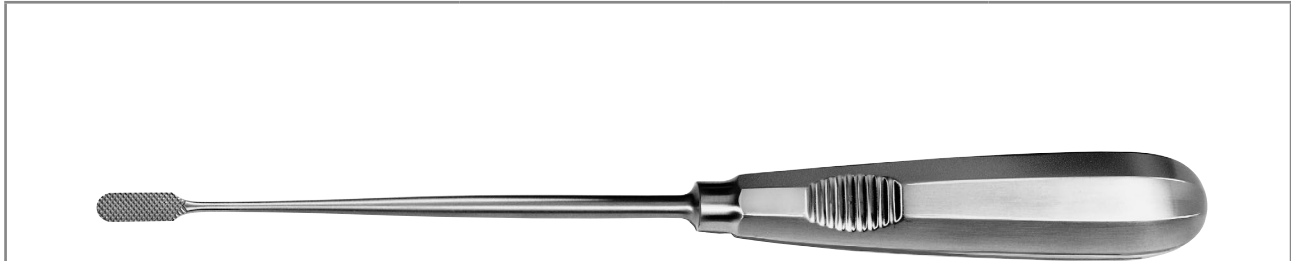

# Hand Instruments

## Cartilage File, Spoon, Curette



Knee

1.4

|  | Version  | WL     | Product no.     |
|--|----------|--------|-----------------|
| <p><b>Cartilage file straight WL 125mm W 6.25mm</b></p>  <p>rough</p>            | Straight | 125 mm | <b>8436.501</b> |
| <p><b>Cartilage file convex WL 125mm W 6.25mm</b></p>  <p>rough</p>             | Convex   |        | <b>8436.511</b> |
| <p><b>Cartilage file concave WL 125mm W 6.25mm</b></p>  <p>W 6.25 mm, rough</p> | Concave  |        | <b>8436.521</b> |
| <p><b>Spoon Ø 6.5 x 10mm WL 125mm</b></p>  <p>rough</p>                         | Curved   |        | <b>8436.601</b> |
| <p><b>Curette round Ø 5mm WL 125mm</b></p>  <p>double-blade</p>                 | Angled   |        | <b>8436.701</b> |

# ACL Hammer

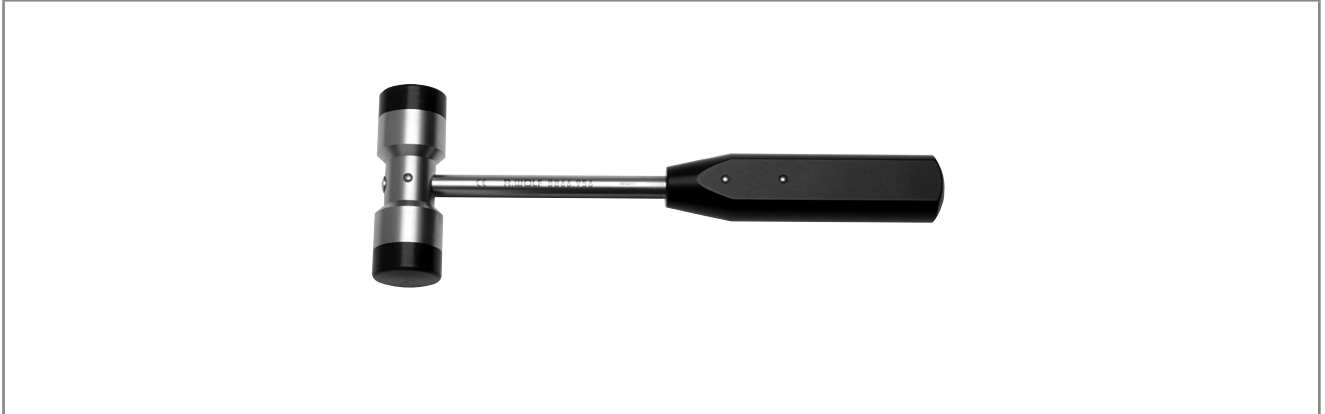

|                                | TL            | Product no.     |
|--------------------------------|---------------|-----------------|
| <b>ACL hammer<br/>TL 248mm</b> | <b>248 mm</b> | <b>8866.956</b> |

Knee  
1.4

VI121 || Subject to modifications. Please note that some products may not be available in all countries. For more detailed information, please consult with your contact partner or directly with Richard Wolf GmbH.

# graft<sup>line</sup>

## Instrument System

for arthroscopic cruciate ligament surgery



### Modular concept

The system's outstanding performance is provided by its unparalleled diversity and universality. **Graftline** offers highly specialized – and in some cases patented – technology for a huge range of surgical options.

- **Efficiency goes hand in hand.** Minimal handles and intuitive connection options for all instruments save on space and weight.
- **ACL and PCL in one instrument.** **Graftline** provides the instruments for anterior and posterior cruciate ligament plastic surgery in intelligent combinations.
- **Well prepared for optimum grip.** With the Graftline instruments and implants, the surgeon is perfectly prepared for all eventualities, for example, if ruptures occur.

### A choice of fixing options

**Graftline** allows the ideal fixation method to be selected for the cruciate ligament graft, without the need for major adjustments. We offer a tried-and-tested range of fixing implants.

### Unique perspectives

**Graftline** gives surgeons access to all methodological channels – from standard techniques to innovative specific solutions. BTB, BT grafts, hamstrings, allografts, oval tunnel technique, and hollow-burr technique: one system – a wealth of possibilities.

# Removal of an Autologous Tendon

## Semitendinosus Tendon and/or Gracilis Tendon

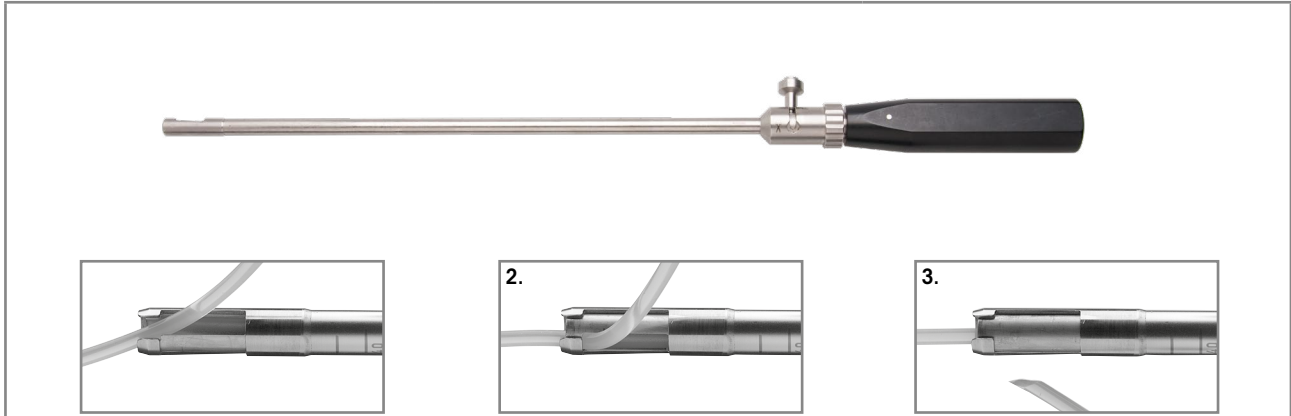

| 1. Retract  |  | 2. Secure |        | 3. Sever        |  |
|---|--|-----------|--------|-----------------|--|
|   |  | Ring Ø    | WL     | Product no.     |  |
|  <p><b>Tendon stripper, universal<br/>300mm, SZ8 mm</b></p> <p>by Pässler</p> <ul style="list-style-type: none"> <li>● Universal use: open / closable / cutting function</li> <li>● Blunt distal end</li> <li>● Can be disassembled</li> </ul> |  | 8.0 mm    | 300 mm | <b>8866.951</b> |  |

|   |  | Ring Ø | WL     | Product no.      |  |
|---|--|--------|--------|------------------|--|
|  <p><b>Tendon stripper standard<br/>Ø 7mm</b></p> <ul style="list-style-type: none"> <li>● Closed</li> <li>● Sharp distal end</li> </ul> |  | 8.0 mm | 300 mm | <b>891610070</b> |  |

VII/21 || Subject to modifications. Please note that some products may not be available in all countries. For more detailed information, please consult with your contact partner or directly with Richard Wolf GmbH.

Knee  
1.5

## Removal of an Autologous Tendon

Quadriceps or patellar tendon



|                   |  | Inner Ø | Outer Ø | WL    | Product no.     |
|-------------------|--|---------|---------|-------|-----------------|
| Hollow burr SZ 8  | <ul style="list-style-type: none"> <li>For efficient removal of the bone blocks for BT or BTB transplants when using the quadriceps or patellar tendon</li> <li>for application with the bee-system II oscillating ream machine F-31-700-00</li> </ul> | 8,4 mm  | 9,4 mm  | 90 mm | <b>8869.841</b> |
| Hollow burr SZ 9  |  | 9,4 mm  | 10,4 mm |       | <b>8869.843</b> |
| Hollow burr SZ 10 |  | 10,4 mm | 11,4 mm |       | <b>8869.844</b> |



|                       |   | Inner Ø | Outer Ø | WL     | Product no.     |
|-----------------------|---|---------|---------|--------|-----------------|
| Hollow drill bit SZ 8 | <ul style="list-style-type: none"> <li>for application with the bee-system II oscillating ream machine F-31-700-00</li> </ul> | 7,4 mm  | 8,5 mm  | 185 mm | <b>8869849</b>  |
| Hollow drill bit SZ 9 |   | 8,4 mm  | 9,5 mm  |        | <b>8869.851</b> |
| Hollow drill bit SZ10 |   | 9,4 mm  | 10,5 mm |        | <b>8869.852</b> |

## Removal of an Autologous Tendon

Quadriceps or patellar tendon



|                            |   | Inner Ø | Outer Ø | WL     | Product no.     |
|----------------------------|---|---------|---------|--------|-----------------|
| <b>Bone elevator SZ 8</b>  | <ul style="list-style-type: none"> <li>Release the bone blocks from the patella after using the hollow burrs</li> <li>different diameters to remove the bones blocks</li> </ul> | 8,4 mm  | 11,1 mm | 130 mm | <b>8868.921</b> |
| <b>Bone elevator SZ 9</b>  |   | 9,4 mm  | 11,2 mm |        | <b>8868.922</b> |
| <b>Bone elevator SZ 10</b> |   | 10,5 mm | 12,5 mm |        | <b>8868.923</b> |







|                               |   | Outer Ø | WL     | Product no.     |
|-------------------------------|---|---------|--------|-----------------|
| <b>Suture puller WL 350mm</b> | <ul style="list-style-type: none"> <li>Passing the threads to pull in the transplant into the hollow burrs</li> </ul> | 4 mm    | 350 mm | <b>8869.921</b> |

graft<sup>line</sup>

Graft Fixation

Implant-free press-fit fixation for patella or quadriceps tendon

|  |                     |        |                 |
|--|---------------------|--------|-----------------|
|  |                     | WL     | Product no.     |
|   | for transfibial use | 110 mm | <b>8869.991</b> |
| <b>Curved plunger WL 110mm</b>   |                     |        |                 |

|  |                                     |        |                 |
|--|-------------------------------------|--------|-----------------|
|  |                                     | WL     | Product no.     |
|   | for use via the anteromedial portal | 110 mm | <b>8869.993</b> |
| <b>Pusher straight WL 110mm</b>  |                                     |        |                 |



|   |   | Product no.     |
|---|---|-----------------|
|    | <b>Preparation table. tendon prep. bndl</b><br>consisting of:<br>Preparation table (88669023)<br>Preparation plate (8866905)<br>Transplant template SZ 5-13mm (8866953)<br>Clamp insert (8866962)<br>Hook clamp (8866935)<br>Parallel screw clamp (8866961)<br>RIWObutton interface (8866969)<br>Tendon transplantat BT / BTB 6mm (8866966)<br>Tendon transplantat BT / BTB 8mm (8866968)<br>Leading hook (8866936) | <b>88669700</b> |
|    | <b>Preparation table</b><br>(LxWxH) 390 mm x 190 mm x 6 mm  | <b>88669023</b> |
|  | <b>Preparation plate</b><br>(LxB) 380 mm x 60 mm  | <b>8866905</b>  |
|  | <b>Transplant template SZ 5-13mm</b><br>oval-shaped tunnels<br>D 5 x 10, D 6 x 12, D 7 x 14   | <b>8866953</b>  |
|  | <b>Clamp insert</b>   | <b>8866962</b>  |
|  | <b>Hook clamp</b>   | <b>8866935</b>  |
|  | <b>Parallel screw clamp</b>   | <b>8866961</b>  |
|  | <b>RIWObutton interface</b>   | <b>8866969</b>  |
|  | <b>Tendon transplantat BT / BTB 6mm</b>   | <b>8866966</b>  |
|   | <b>Tendon transplantat BT / BTB 8mm</b>   | <b>8866968</b>  |
|  | <b>Leading hook</b>   | <b>8866936</b>  |





|   | With coupling | Inner Ø | Product no.      |
|---|---------------|---------|------------------|
|  <p><b>Modular handle I-shaped</b><br/>cannulated</p>                  | ●             | 3.5 mm  | <b>893011135</b> |
|  <p><b>Modular handle impact / deflection plate</b><br/>cannulated</p> |               | 3.5 mm  | <b>893011136</b> |
|  <p><b>Handle I-shaped ID 3.2mm</b><br/>cannulated</p>                |               | 3.2 mm  | <b>893011132</b> |
|  <p><b>Modular handle, t-shaped</b><br/>cannulated</p>               |               | 4.0 mm  | <b>893011137</b> |



891013 050/060/070/080/510/612/714



891014070/080/090/100

| ACL  |                              | Size              | Color coding | ∅      | WL     | Product no. |
|--|------------------------------|-------------------|--------------|--------|--------|-------------|
| <br>cannulated, for the anteromedial portal  | ACL aiming device SZ 5mm     | 5 mm              | blue         | 2.5 mm | 120 mm | 891013050   |
|  | ACL aiming device SZ 6mm     | 6 mm              | green        |        |        | 891013060   |
|  | ACL aiming device SZ 7mm     | 7 mm              | red          |        |        | 891013070   |
|  | ACL aiming device SZ 8mm     | 8 mm              | none         |        |        | 891013080   |
| <br>cannulated, for the anteromedial portal | ACL aiming device SZ 5x10mm  | oval<br>5 x 10 mm | blue         | 2.5 mm | 120 mm | 891013510   |
|  | ACL aiming device SZ 6x12mm  | oval<br>6 x 12 mm | green        |        |        | 891013612   |
|  | ACL aiming device SZ 7x14mm  | oval<br>7 x 14 mm | red          |        |        | 891013714   |
| <br>cannulated, for the transtibial portal  | ACL aiming device AT SZ 5mm  | 5 mm              | blue         | 2.5 mm | 120 mm | 891015050   |
|  | ACL aiming device AT SZ 6mm  | 6 mm              | green        |        |        | 891015060   |
|  | ACL aiming device AT SZ 7mm  | 7 mm              | red          |        |        | 891015070   |
| <b>PCL</b>   |                              |                   |              |        |        |             |
| <br>cannulated, for the anteromedial portal | PCL aiming device AL SZ 7mm  | 7 mm              | red          | 2.5 mm | 120 mm | 891014070   |
|  | PCL aiming device AL SZ 8mm  | 8 mm              | none         |        |        | 891014080   |
|  | PCL aiming device AL SZ 9mm  | 9 mm              | yellow       |        |        | 891014090   |
|  | PCL aiming device AL SZ 10mm | 10 mm             | white        |        |        | 891014100   |



● For use with the modular handles

**UniCracker**





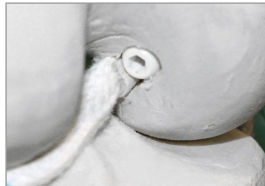

| For use with the modular handles   |   | WL     | Product no.      |
|--|---|--------|------------------|
|  <p><b>Univ. tunnel notcher</b><br/>Ø 4–9 mm WL 130mm</p> | <p>Impacting chisel for indentation of the tunnel<br/>from Ø 4 to 9 mm, cannulated 2.5 mm</p> | 130 mm | <b>891611110</b> |

| For use with the modular handles  |   | WL     | Product no.      |
|---|---|--------|------------------|
|  <p><b>Notch chisel WL 130mm</b><br/>one-sided grinding<br/>cannulated, Ø 2.5 mm</p> | <p>Gentle graft fixation when using interference screws</p> | 130 mm | <b>891511000</b> |



|  |   | WL     | Product no.      |
|--|---|--------|------------------|
|  <p><b>Tunnel probe WL 140 mm</b><br/>graduated</p> | <p>For determining the length of the femoral tunnel –<br/>particularly when using the RIWObutton<br/>to determine the loop length</p> | 140 mm | <b>891510012</b> |

## Preparing the Femoral Tunnel



Instruments for preparing oval tunnels



| For use with the modular handles  |  |  | Size      | Color coding | WL     | Product no. |
|---|--|--|-----------|--------------|--------|-------------|
| <br><b>Tunnel rasp</b><br>oval, cannulated<br>Ø 2.5 mm | <b>Tunnel rasp</b><br>Ø 5 x 10mm<br>WL 130mm | For preparing the<br>oval-shaped femoral<br>tunnel on the joint side | 5 x 10 mm | blue         | 130 mm | 891611101   |
|   | <b>Tunnel rasp</b><br>Ø 6 x 12mm<br>WL 130mm |  | 6 x 12 mm | green        |        | 891611102   |
|   | <b>Tunnel rasp</b><br>Ø 7 x 14mm<br>WL 130mm |  | 7 x 14 mm | red          |        | 891611103   |

VI121 || Subject to modifications. Please note that some products may not be available in all countries. For more detailed information, please consult with your contact partner or directly with Richard Wolf GmbH.







| For use with the modular handles  |                          |  | ∅    | WL     | Product no.      |
|---|--------------------------|--|------|--------|------------------|
|  <p><b>Compactor</b><br/>cannulated<br/>∅ 2.5 mm<br/>graduated</p> | <b>Compactor SZ 8</b>    | Compacting the spongiosa during simultaneous, asymmetric formation of the femoral tunnel using a compactor head flattened at the side.<br>For the positioning and press-fit anchorage of bone plugs for BT and BTB grafts.<br>● For use with the modular handles | 8.0  | 290 mm | <b>891511708</b> |
|   | <b>Compactor SZ 9</b>    |  | 9.0  |        | <b>891511709</b> |
|   | <b>Compactor SZ 10</b>   |  | 10.0 |        | <b>891511710</b> |
| Also:   |                          |  |      |        |                  |
|    | <b>Deflection sleeve</b> | For removal of compactors  |      |        | <b>8868.992</b>  |
|    | <b>Tunnel stopper</b>    | For the direct closure of tibial drill holes   |      |        | <b>8868.941</b>  |



VII/21 || Subject to modifications. Please note that some products may not be available in all countries. For more detailed information, please consult with your contact partner or directly with Richard Wolf GmbH.

**Single bundle ACL reconstruction**



|   | Adjustable alignment device<br>bndl<br>consisting of:   | Product no.bndl |          |          |
|---|---|-----------------|----------|----------|
|   |   | Product no.     | 8874.013 | 8874.014 |
|   | Base section for standard tibial,<br>graduated<br>for alignment hook and spoon and<br>for drill guide | 8874.113        | ●        | ●        |
|  | Aiming spoon tibial ACL   | 8874.123        |          | ●        |
|  | Aiming hook tibial ACL  | 8874.121        | ●        |          |
|  | Alignment wire guide standard SZ 2.5  | 8874.131        | ●        | ●        |

**Double-bundle ACL reconstruction**

|   |  | Product no. |
|---|--|-------------|
|  | Alignment ARC ZG tibial ACL right<br>For the double-bundle technique on the right knee | 8874130     |
|  | Zielbügel ZG Tibial ACL links DB<br>For the double-bundle technique on the left knee   | 88741301    |

**PCL reconstruction**

|   |                        | Product no. |
|---|------------------------|-------------|
|  | Aiming spoon ZG tibial | 8874129     |



Knee  
1.5



## Preparing the Tibial Tunnel

Hollow drill extension set for harvesting bone cylinders







| Hollow drill bit and Ejector | Inner Ø | Outer Ø | WL     | Product no.     |
|------------------------------|---------|---------|--------|-----------------|
| <b>Hollow drill bit SZ 8</b> | 8,5 mm  | 7,4 mm  | 185    | <b>8869849</b>  |
| also: <b>Ejector SZ 8</b>    |         |         |        | <b>8869850</b>  |
| <b>Hollow drill bit 9</b>    | 9,5 mm  | 8,4 mm  | 185 mm | <b>8869.851</b> |
| also: <b>Ejector SZ 9</b>    |         |         |        | <b>8869.852</b> |
| <b>Hollow drill bit 10</b>   | 10,5 mm | 9,4 mm  | 185 mm | <b>8869.853</b> |
| also: <b>Ejector SZ 10</b>   |         |         |        | <b>8869.854</b> |

| Base section, aiming spoon and aiming hook  |  | Product no.     |
|---|--|-----------------|
|  | <b>Base section for tibial drill graduated</b> | <b>8874.111</b> |
|  | <b>Aiming hook tibial ACL</b>                  | <b>8874.121</b> |
|  | <b>Aiming spoon tibial ACL</b>                 | <b>8874.123</b> |

| Alignment wire guide hollow drill SZ 2.5  |   | Product no.     |
|---|---|-----------------|
|  | <b>Alignment wire guide hollow drill SZ 2.5</b><br>for use with base section 8874.111                                   | <b>8874.151</b> |
|  | <b>Drill guide for hollow drill bit SZ 8</b><br>for use with base section 8874.111 and hollow drill bit 8869849 SZ 8    | <b>8874150</b>  |
|   | <b>Drill guide for hollow drill bit SZ 9</b><br>for use with base section 8874.111 and hollow drill bit 8869.851 SZ 9   | <b>8874.152</b> |
|   | <b>Drill guide for hollow drill bit SZ 10</b><br>for use with base section 8874.111 and hollow drill bit 8869.853 SZ 10 | <b>8874.153</b> |







VI121 || Subject to modifications. Please note that some products may not be available in all countries. For more detailed information, please consult with your contact partner or directly with Richard Wolf GmbH.

|   |  | WL     | Ø       | Product no.      |
|---|--|--------|---------|------------------|
|   |  |        |         |                  |
| <br><br><br><br><b>Cross impactor</b><br>with distal cross profile<br>cannulated<br><br>For alignment wire / Kirschner wire<br>Ø 2.5 mm | <b>Cross impactor Ø 5mm WL 150mm</b>                         | 150 mm | 5,0 mm  | <b>891511005</b> |
|   | <b>Cross impactor Ø 5.5mm WL 150mm</b>                       |        | 5,5 mm  | <b>891511055</b> |
|   | <b>Cross impactor Ø 6.0mm WL 150mm</b>                       |        | 6,0 mm  | <b>891511006</b> |
|   | <b>Cross impactor Ø 6.5mm WL 150mm</b>                       |        | 6,5 mm  | <b>891511065</b> |
|   | <b>Cross impactor Ø 7.0mm WL 150mm</b>                       |        | 7,0 mm  | <b>891511007</b> |
|   | <b>Cross impactor Ø 7.5mm WL 150mm</b>                       |        | 7,5 mm  | <b>891511075</b> |
|   | <b>Cross impactor Ø 8.0mm WL 150mm</b>                       |        | 8,0 mm  | <b>891511008</b> |
|   | <b>Cross impactor Ø 8.5mm WL 150mm</b>                       |        | 8,5 mm  | <b>891511085</b> |
|   | <b>Cross impactor Ø 9.0mm WL 150mm</b>                       |        | 9,0 mm  | <b>891511009</b> |
|   | <b>Cross impactor Ø 9.5mm WL 150mm</b>                       |        | 9,5 mm  | <b>891511095</b> |
|   | <b>Cross impactor Ø 10.0mm WL 150mm</b>                      |        | 10,0 mm | <b>891511010</b> |
|   | <b>Cross impactor Ø 10.5mm WL 150mm</b>                      |        | 10,5 mm | <b>891511105</b> |
|   | <b>Cross impactor Ø 11.0mm WL 150mm</b>                      |        | 11,0 mm | <b>891511011</b> |
| <b>also:</b>  |  |        |         |                  |
|    | <b>Modular handle, T-shaped</b><br>with coupling, cannulated |        |         | <b>893011137</b> |

graft<sup>line</sup>

## Preparing the Tibial Tunnel

Cannulated head drill

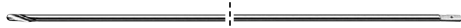



|  |                     | WL                                 | Ø       | Product no.       |
|--|---------------------|------------------------------------|---------|-------------------|
| <br><br><b>Head drill</b><br>cannulated, Ø 2.65 mm<br>TiN coating<br>For alignment wire / Kirschner wire<br>Ø 2.5 mm | Head drill Ø 4.5mm  | 145 mm                             | 4.5 mm  | <b>89960.1045</b> |
|  | Head drill Ø 5mm    |                                    | 5.0 mm  | <b>89960.1050</b> |
|  | Head drill Ø 5.5mm  |                                    | 5.5 mm  | <b>89960.1055</b> |
|  | Head drill Ø 6mm    |                                    | 6.0 mm  | <b>89960.1060</b> |
|  | Head drill Ø 6.5mm  |                                    | 6.5 mm  | <b>89960.1065</b> |
|  | Head drill Ø 7mm    |                                    | 7.0 mm  | <b>89960.1070</b> |
|  | Head drill Ø 7.5mm  |                                    | 7.5 mm  | <b>89960.1075</b> |
|  | Head drill Ø 8mm    |                                    | 8.0 mm  | <b>89960.1080</b> |
|  | Head drill Ø 8.5mm  |                                    | 8.5 mm  | <b>89960.1085</b> |
|  | Head drill Ø 9mm    |                                    | 9.0 mm  | <b>89960.1090</b> |
|  | Head drill Ø 9.5mm  |                                    | 9.5 mm  | <b>89960.1095</b> |
|  | Head drill Ø 10mm   |                                    | 10.0 mm | <b>89960.1010</b> |
|  | Head drill Ø 10.5mm |                                    | 10.5 mm | <b>89960.1910</b> |
|  | Head drill Ø 11mm   |                                    | 11.0 mm | <b>89960.1011</b> |
|  | Head drill Ø 11.5mm |                                    | 11.5 mm | <b>89960.1911</b> |
| Head drill Ø 12mm  | 12.5 mm             | <b>89960.1012</b>                  |         |                   |
| Head drill Ø 12.5mm  | 12.5 mm             | <b>89960.1912</b>                  |         |                   |
| Head drill Ø 13mm  | 13.0 mm             | <b>89960.1013</b>                  |         |                   |
| <br><b>Kirschner alignment wire Ø 2.5mm</b><br>triangular grinding  |                     | TL 300 mm<br>without suture eyelet | 2.5 mm  | <b>89120.3025</b> |
| <br><b>Kirschner alignment wire Ø 2.5mm</b><br>spiral grinding  |                     | TL 310 mm<br>without suture eyelet | 2.5 mm  | <b>89960.1025</b> |
| <br><b>Kirschner alignment wire Ø 2.5mm</b><br>spiral grinding  |                     | TL 430 mm<br>with suture eyelet    | 2.5 mm  | <b>89960.1125</b> |

**graft***line*

**Perforated Baskets for Instruments**

**Knee Arthroscopy**

Sterilization – storage – transport

| Illustration   | Description  | Product no.         |
|--|--|---------------------|
|  <p><b>Perf. basket –<br/>knee arthrosc. Basic set</b></p>    | <p>Holds: knee arthroscopy basic set, for sterilization (steam and low-temperature), storage and transport, with instrument holders,<br/>inner dimensions (wxhxd): 513x134x233mm,<br/>outer dimensions (wxhxd): 549x150x250mm</p>                      | <p><b>33007</b></p> |
|  <p><b>Perf. basket –<br/>knee arthrosc. ACL/PCL 1</b></p>   | <p>Holds: instrument set for knee arthroscopy ACL/PCL 1, for sterilization (steam and low-temperature), storage and transport, with instrument holders,<br/>inner dimensions (wxhxd): 513x134x233mm,<br/>outer dimensions (wxhxd): 549x150x250mm</p>   | <p><b>33008</b></p> |
|  <p><b>Perf. basket –<br/>knee arthrosc. ACL/PCL 2</b></p>  | <p>Holds: instrument set for knee arthroscopy ACL/PCL 2, f for sterilization (steam and low-temperature), storage and transport, with instrument holders,<br/>inner dimensions (wxhxd): 513x134x233mm,<br/>outer dimensions (wxhxd): 549x150x250mm</p> | <p><b>33009</b></p> |
|  <p><b>Perf. basket<br/>For knee arthrosc. prep tab</b></p> | <p>Holds: knee arthroscopy preparation table, for sterilization (steam and low-temperature), storage and transport, with instrument holders,<br/>inner dimensions (wxhxd): 513x134x233mm,<br/>outer dimensions (wxhxd): 549x150x250mm</p>              | <p><b>33010</b></p> |

passend für Standard Container (1 STE = 1 Sterilguteinheit)

graft<sup>line</sup>

Graft Fixation

Tendon anchor / RIWObutton

| Tendon anchor   |   | Size | Product no. |
|---|---|------|-------------|
| <b>T-Lock OSTEOTRANS</b><br> | T-Lock OSTEOTRANS<br>tendon anchor, sterile | 6    | OLRA-6      |
|   |   | 7    | OLRA-7      |
|   |   | 8    | OLRA-8      |
|   |   | 9    | OLRA-9      |

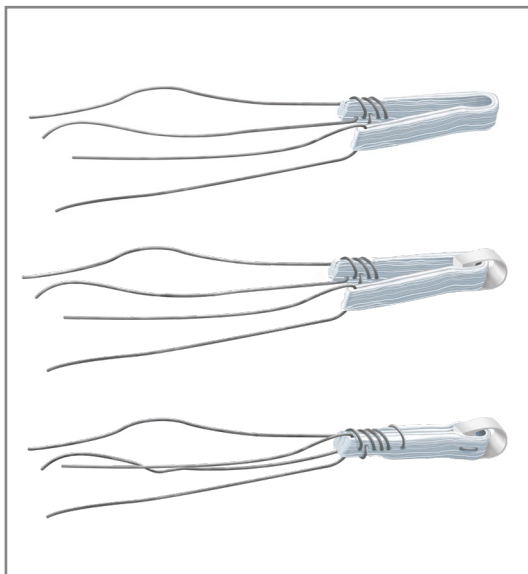

**BioactIF** OSTEOTRANS

"OK" interference screws

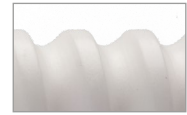

|                                     | Thread Ø | Length | Hole   | Product no.    |
|-------------------------------------|----------|--------|--------|----------------|
| BioactIF OSTEOTRANS 7 X 25, sterile | / mm     | 25 mm  | 2,2 mm | <b>OK0725A</b> |
| BioactIF OSTEOTRANS 7 X 30, sterile |          | 30 mm  |        | <b>OK0730A</b> |
| BioactIF OSTEOTRANS 8 X 25, sterile | 8 mm     | 25 mm  |        | <b>OK0825</b>  |
| BioactIF OSTEOTRANS 8 X 30, sterile |          | 30 mm  |        | <b>OK0830</b>  |
| BioactIF OSTEOTRANS 9 X 25, sterile | 9 mm     | 25 mm  |        | <b>OK0925</b>  |
| BioactIF OSTEOTRANS 9 X 30, sterile |          | 30 mm  |        | <b>OK0930</b>  |



| Screwdriver  | For interference screws with thread size | Product no.      |
|--|--|------------------|
|  <p><b>Screwdriver OK/BK SZ 7 -11mm</b><br/>cannulated, color code red, graduated</p> | 7-11 mm                                  | <b>891800030</b> |



| Thread cutter   | For OK screws                       | Product no.                   |
|---|-------------------------------------|-------------------------------|
|  | Thread cutter for OK screws SZ 7 mm | Size 7 mm<br><b>891800700</b> |
|   | Thread cutter for OK screws SZ 8 mm | Size 8 mm<br><b>891800800</b> |
|   | Thread cutter for OK screws SZ 9 mm | Size 9 mm<br><b>891800900</b> |



| Guide wire   | Ø      | TL     | Product no.       |
|--|--------|--------|-------------------|
|  <p><b>Nitinol guide wire</b><br/>Ø 1.2mm</p> | 1.2 mm | 350 mm | <b>89120.2012</b> |

# graft<sup>line</sup>

## Graft Fixation

Bioactive and bioresorbable interference screws  
"BK-Serie"

### Bioact<sup>IF</sup> OSTEOTRANS

"BK" interference screws





|                                      | Thread Ø | Length | Hole   | Product no.   |
|--------------------------------------|----------|--------|--------|---------------|
| BioactIF OSTEOTRANS 6 X 20, sterile  | 6 mm     | 20 mm  | 1.7 mm | <b>BK0620</b> |
| BioactIF OSTEOTRANS 7 X 20, sterile  | 7 mm     | 20 mm  |        | <b>BK0720</b> |
| BioactIF OSTEOTRANS 7 X 25, sterile  |          | 25 mm  |        | <b>BK0725</b> |
| BioactIF OSTEOTRANS 7 X 30, sterile  |          | 30 mm  |        | <b>BK0730</b> |
| BioactIF OSTEOTRANS 8 X 20, sterile  | 8 mm     | 20 mm  |        | <b>BK0820</b> |
| BioactIF OSTEOTRANS 8 X 25, sterile  |          | 25 mm  |        | <b>BK0825</b> |
| BioactIF OSTEOTRANS 8 X 30, sterile  |          | 30 mm  |        | <b>BK0830</b> |
| BioactIF OSTEOTRANS 9 X 20, sterile  | 9 mm     | 20 mm  |        | <b>BK0920</b> |
| BioactIF OSTEOTRANS 9 X 25, sterile  |          | 25 mm  |        | <b>BK0925</b> |
| BioactIF OSTEOTRANS 9 X 30, sterile  |          | 30 mm  |        | <b>BK0930</b> |
| BioactIF OSTEOTRANS 10 X 25, sterile | 10 mm    | 25 mm  |        | <b>BK1025</b> |
| BioactIF OSTEOTRANS 10 X 30, sterile |          | 30 mm  |        | <b>BK1030</b> |

891800020



891800030



| Screwdriver   |  | for interference screws with thread size | Product no.      |
|---|--|--|------------------|
|  | <b>Screwdriver BK SZ 6MM</b><br>cannulated, color code black, graduated      | 6 mm                                     | <b>891800020</b> |
|  | <b>Screwdriver OK/BK SZ 7 -11mm</b><br>cannulated, color code red, graduated | 7-11 mm                                  | <b>891800030</b> |

Guide wire



Nitinol guide wire  
Ø 1.2mm

Ø

1.2 mm

TL

350 mm

Product no.

**89120.2012**

graft<sup>line</sup>

Graft Fixation

Bioactive and bioresorbable interference screws

"RK-Serie"

**Bioact<sup>IF</sup> OSTEOTRANS**

"RK" interference screws



| conical, absorbable, sterile       | Thread Ø | Length | Hole   | Product no.   |
|------------------------------------|----------|--------|--------|---------------|
| Bioactif OSTEOTRANS OD 6mm L 20mm  | 6 mm     | 20 mm  | 1,5 mm | <b>RK0620</b> |
| Bioactif OSTEOTRANS OD 7mm L 20mm  | 7 mm     | 20 mm  |        | <b>RK0720</b> |
| Bioactif OSTEOTRANS OD 7mm L 25mm  |          | 25 mm  |        | <b>RK0725</b> |
| Bioactif OSTEOTRANS OD 7mm L 30mm  |          | 30 mm  |        | <b>RK0730</b> |
| Bioactif OSTEOTRANS OD 8mm L 20mm  | 8 mm     | 20 mm  |        | <b>RK0820</b> |
| Bioactif OSTEOTRANS OD 8mm L 25mm  |          | 25 mm  |        | <b>RK0825</b> |
| Bioactif OSTEOTRANS OD 8mm L 30mm  |          | 30 mm  |        | <b>RK0830</b> |
| Bioactif OSTEOTRANS OD 9mm L 20mm  | 9 mm     | 20 mm  |        | <b>RK0920</b> |
| Bioactif OSTEOTRANS OD 9mm L 25mm  |          | 25 mm  |        | <b>RK0925</b> |
| Bioactif OSTEOTRANS OD 9mm L 30mm  |          | 30 mm  |        | <b>RK0930</b> |
| Bioactif OSTEOTRANS OD 10mm L 25mm | 10 mm    | 25 mm  |        | <b>RK1025</b> |

891800021



891800031





|   |  | for interference screws with thread size | Product no.      |
|---|--|--|------------------|
|  | <b>Screwdriver RK SZ 5 -6mm</b><br>cannulated, color code red, graduated     | 6 mm                                     | <b>891800021</b> |
|  | <b>Screwdriver RK GR 7 -11mm</b><br>cannulated, color code yellow, graduated | 7 - 11 mm                                | <b>891800031</b> |

graft<sup>line</sup>

Graft Fixation

Guide Wire



| Guide wire   | Ø      | TL     | Product no.       |
|--|--------|--------|-------------------|
|  Nitinol guide wire Ø 1.2mm | 1.2 mm | 350 mm | <b>89120.2012</b> |





## Shoulder

## Shoulder

---

**1** Standard Equipment / Arthroscopes

---

**2** ARTHROline Punches

---

**3** Hook Probe / Marking Rod

---

**4** Reconstructive Shoulder Arthroscopy

---

## Basic Equipment

### for shoulder arthroscopy

| Product  | Product no.       | Quantity | Catalog / Section      |
|--|-------------------|----------|------------------------|
| <b>Endoscopes and Instruments</b>  |                   |          |                        |
| PANOVIEW telescope 30° Ø 4mm SL 170mm  | <b>8880.543</b>   | 1        | Orthopedics / Shoulder |
| Fiber light cable bndl, Ø 3.5mm, 2.3m long                                     | <b>806635231</b>  | 1        | Orthopedics / Shoulder |
| Sheath for arthroscope OD 6mm  | <b>89121.1260</b> | 1        | Orthopedics / Shoulder |
| Obturator for arthroscope OD 5.5/6/6.3mm tip, semi-blunt                       | <b>89121.0542</b> | 1        | Orthopedics / Shoulder |
| Hook probe WL 115mm H 4.5mm graduated  | <b>8399.95</b>    | 1        | Orthopedics / Shoulder |
| ARTHROline punch W 4.6mm H 1.6mm jaws curved upward                            | <b>89140.0102</b> | 1        | Orthopedics / Shoulder |
| ARTHROline punch W 5.5mm H 1.6mm jaws curved upward, sheath curved to the left | <b>89140.0103</b> | 1        | Orthopedics / Shoulder |
| ARTHROline punch W 4.6mm H 1.6mm jaw section serrated, sheath curved upward    | <b>89140.0122</b> | 1        | Orthopedics / Shoulder |
| ARTHROline hook punch W 4mm H 21.1mm straight jaw section                      | <b>89140.0405</b> | 1        | Orthopedics / Shoulder |

## Overview

Shoulder

2.1

| arthro<br><i>lution</i> |  |                               | Fingers, toes    | Hand             | Foot, elbow      |                  | Knee, shoulder, hip |
|-------------------------|--|-------------------------------|------------------|------------------|------------------|------------------|---------------------|
| Telescope Ø             |  |                               | 1.9 mm           | 2.4 mm           | 2.7 mm           |                  | 4.0 mm              |
| Telescopes              | 30°  | PANOVIEW telescope            | <b>8860453</b>   | <b>8871413</b>   | <b>8476.433</b>  | <b>8672.422</b>  | <b>8880.543</b>     |
|                         |  | PANOVIEW wide angle telescope |                  |                  |                  |                  | <b>8885.443</b>     |
|                         | 70°  | PANOVIEW telescope            |                  |                  |                  |                  | <b>8880.545</b>     |
|                         |  | PANOVIEW wide angle telescope |                  |                  |                  |                  | <b>8885.445</b>     |
| Sheath WL               |  |                               | 40 mm            | 60 mm            | 77.5 mm          | 145 mm           | 130 mm              |
| Sheaths                 | with 1 irrigation stopcock, fixed                    |                               | <b>891220124</b> | <b>891220132</b> |                  |                  |                     |
|                         | with 2 irrigation stopcocks, fixed                   |                               |                  |                  |                  |                  | <b>89121.0260</b>   |
|                         | with 1 irrigation stopcock, rotatable                |                               |                  |                  |                  | <b>891241141</b> |                     |
|                         | with 2 irrigation stopcocks, rotatable               |                               |                  | <b>891221232</b> | <b>891221241</b> | <b>891241241</b> | <b>89121.1260</b>   |
|                         | High-Flow with 1 irrigation stopcock, fixed          |                               | <b>891220128</b> |                  |                  |                  |                     |
|                         | High-Flow with 2 irrigation stopcocks, rotatable     |                               |                  | <b>891221235</b> |                  |                  | <b>89121.1263</b>   |
|                         | Small-caliber with 2 irrigation stopcocks, rotatable |                               |                  |                  |                  |                  | <b>891221255</b>    |
| Obturator               | blunt  |                               |                  |                  | <b>891222754</b> |                  | <b>89121.0544</b>   |
|                         | semi-blunt   |                               | <b>891221952</b> | <b>891222452</b> |                  |                  | <b>89121.0542</b>   |
|                         | conical blunt  |                               |                  |                  | <b>891222750</b> | <b>891242750</b> | <b>89121.0540</b>   |
|                         | sharp  |                               |                  |                  |                  | <b>891242761</b> | <b>89121.0640</b>   |
|                         | conical pointed                                      |                               | <b>891221962</b> | <b>891222462</b> | <b>891222762</b> |                  |                     |
| Sealing part for sheath |  |                               |                  |                  |                  | <b>891040000</b> |                     |

# Arthroscope with PANOVIEW Telescope Ø 4 mm

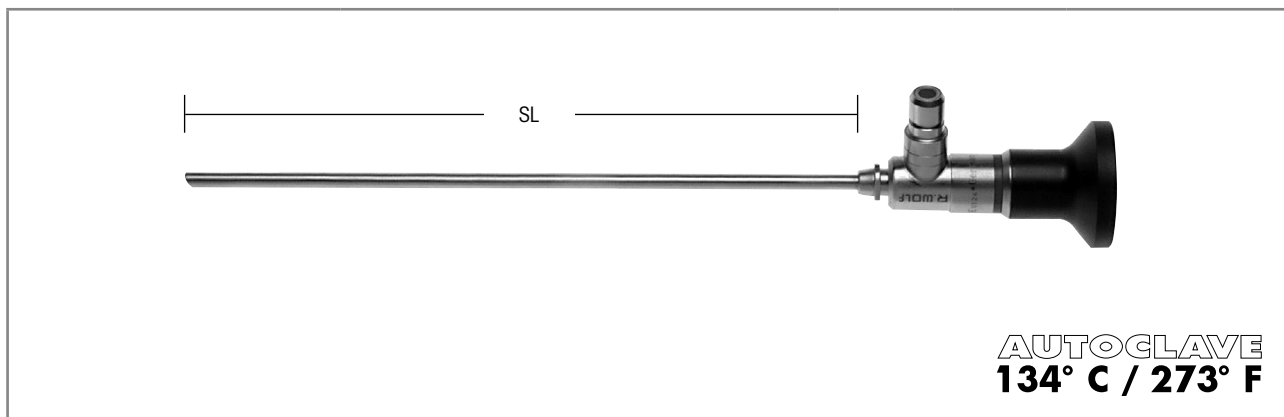

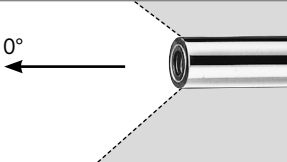
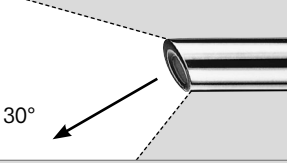
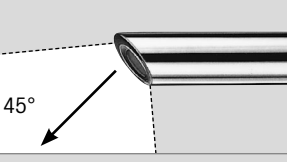
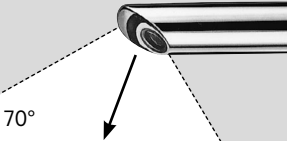
| Direction of view  |  | SL     | Ø      | Product no. |
|--|--|--------|--------|-------------|
| <br>0°   | PANOVIEW<br>telescope 0° Ø 4mm SL 170mm  | 170 mm | 4.0 mm | 8880.541    |
| <br>30° | PANOVIEW<br>telescope 30° Ø 4mm SL 170mm |        |        | 8880.543    |
| <br>45° | PANOVIEW<br>telescope 45° Ø 4mm SL 170mm |        |        | 8880.544    |
| <br>70° | PANOVIEW<br>telescope 70° Ø 4mm SL 176mm | 176 mm |        | 8880.545    |





| Recommended accessories   |                              | Product no.      |
|---|------------------------------|------------------|
| <b>Perf. basket for standard telescope 1</b>  | (L x B x H) 297 x 59 x 54 mm | <b>38015</b>     |
| <b>Fiber light cable bndl</b><br>Comprising:<br>Fiber light cable (80663523),<br>adapter, projector to light cable (8095.07), and<br>adapter, light cable to endoscope (809509) | Ø 3.5 mm, 2.3 m long         | <b>806635231</b> |

**arthro** *lution* Sheath for Arthroscope

with automatic click-lock mechanism

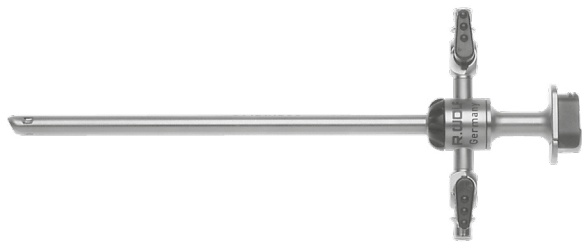
Shoulder

2.1

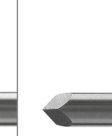
|  |               |                   |                       |         |        |                   |  |  |  |  |
|---|---------------|-------------------|-----------------------|---------|--------|-------------------|--|---|---|---|
|   |               |                   |                       |         |        |                   |  |   |   |   |
| Sheath for arthroscope OD 6mm   |               |                   |                       |         |        |                   |  |   |   |   |
| High-Flow   | Small-caliber | 2 fixed stopcocks | 2 rotatable stopcocks | Outer Ø | WL     | Product no.       |  |   |   |   |
|   |               | ●                 |                       | 6.0 mm  | 132 mm | <b>89121.0260</b> | 89121.0544   | 89121.0542  | 89121.0540  | 89121.0640  |
|   |               |                   | ●                     | 6.0 mm  | 130 mm | <b>89121.1260</b> |  |   |   |   |
| ●   |               |                   | ●                     | 6.3 mm  | 130 mm | <b>89121.1263</b> |  |   |   |   |
|   | ●             |                   | ●                     | 5.5 mm  | 130 mm | <b>891221255</b>  |  |   |   |   |









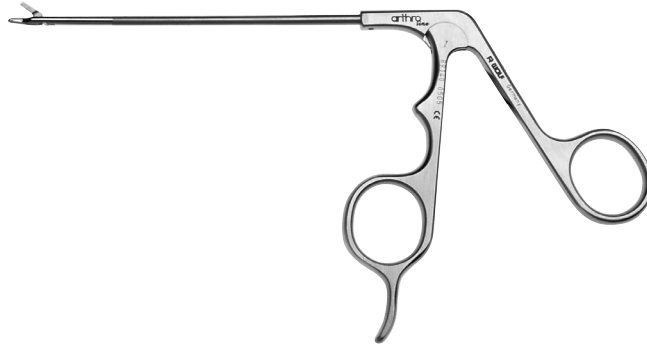

| Spare parts   | Product no.                          |
|---|--------------------------------------|
| Irrigation ring with 1 stopcock   | <b>150081761</b>                     |
| Irrigation ring with 2 stopcocks  | <b>150081762</b>                     |
| Stopcock insert, bundle, cap 3.0mm (PACK= 5 PCS)<br>Also: Disassembly tool                          | <b>896.0002</b><br><b>38310.0001</b> |
| Mounting ring   | <b>15008.1704</b>                    |
| Spare sealing comprising: O-rings, small / large, 5 of each<br>Also: O-ring tool (disassembly tool) | <b>15176.142</b><br><b>15106.230</b> |

| Recommended accessories                        | Product no.       |
|--|-------------------|
| Sealing part for sheath                        | <b>89101.0000</b> |
| Marking rod Ø 4.0mm<br>conical blunt TL 325 mm | <b>8863.75</b>    |

VI121 || Subject to modifications. Please note that some products may not be available in all countries. For more detailed information, please consult with your contact partner or directly with Richard Wolf GmbH.

arthroline Punch





| ARTHROline   | Jaw section (Height x width) | Cut width | WL     | Straight | Curved to the left | Sheath curved upward | Jaw section curved upward | Product no. |   |            |            |
|--|------------------------------|-----------|--------|----------|--------------------|----------------------|---------------------------|-------------|---|------------|------------|
| <b>Punch W 4.6mm H 1.6mm</b><br>movable jaw section serrated<br><br>Sectional view:  | 1.6 x 4.6 mm                 | 3.3 mm    | 120 mm | ●        |                    |                      |                           | 89140.0105  |   |            |            |
| <b>Punch W 4.6mm H 1.6mm</b><br>movable jaw section serrated<br><br>Sectional view:  |                              |           |        |          |                    |                      | ●                         | 89140.0102  |   |            |            |
| <b>Punch W 4.6mm H 1.6mm</b><br>movable jaw section serrated<br><br>Sectional view:  |                              |           |        |          |                    |                      |                           |             | ● | 89140.0122 |            |
| <b>Punch W 5.5mm H 1.6mm</b><br>movable jaw section serrated<br><br>Sectional view:  |                              |           |        |          |                    |                      |                           | ●           |   | ●          | 89140.0101 |
| <b>Punch W 5.5mm H 1.6mm</b><br>movable jaw section serrated<br><br>Sectional view:  |                              |           |        |          |                    |                      |                           |             |   | ●          | 89140.0103 |

VI121 || Subject to modifications. Please note that some products may not be available in all countries. For more detailed information, please consult with your contact partner or directly with Richard Wolf GmbH.

## Hook Probe / Marking Rod



|   | H      | WL     | Product no.     |
|---|--------|--------|-----------------|
| <b>Hook probe WL 115mm H 7mm, graduated</b><br>    | 7.0 mm | 115 mm | <b>8399.901</b> |
| <b>Hook probe WL 115mm H 4.5mm, graduated</b><br> | 4.5 mm |        | <b>8399.95</b>  |

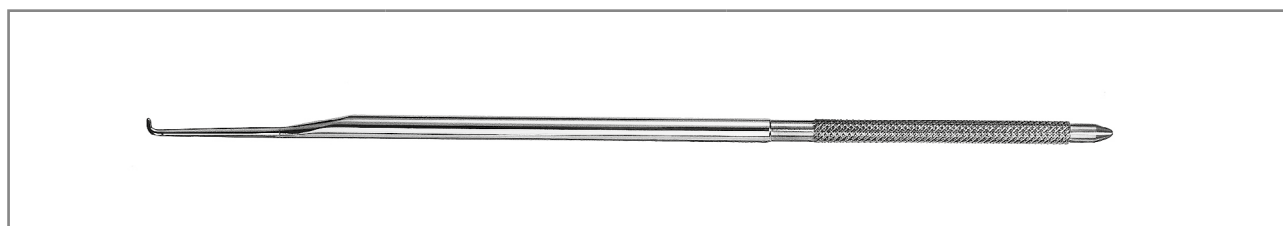

|   | Ø      | TL     | Product no.    |
|---|--------|--------|----------------|
| <b>Hook probe TL 228 mm SZ 4.4mm</b><br> | 4.4 mm | 228 mm | <b>8863.80</b> |

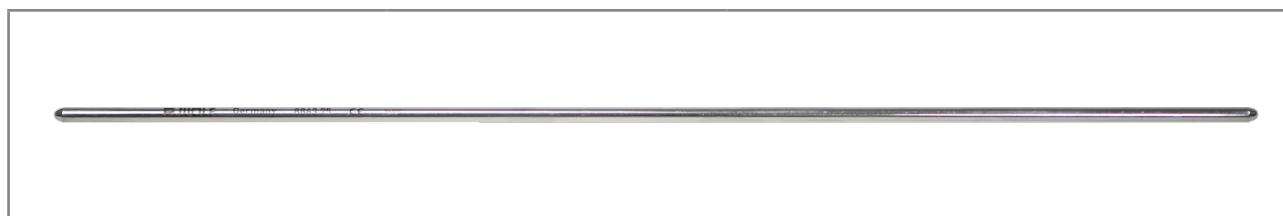

|   | Ø      | TL     | Product no.    |
|---|--------|--------|----------------|
| <b>Marking rod Ø 4.0mm conical blunt</b><br> | 4.0 mm | 325 mm | <b>8863.75</b> |



## Basic Instrument Set

for reconstructive shoulder arthroscopy

| Product                                      | Product no.       | Quantity | Catalog / Section      |
|--|-------------------|----------|------------------------|
| <b>Endoscopes and Instruments</b>            |                   |          |                        |
| Knot pusher WL 170mm                         | <b>89150.3000</b> | 1        | Orthopedics / Shoulder |
| Suture catcher WL 160mm                      | <b>89150.3003</b> | 1        | Orthopedics / Shoulder |
| Concave rasp WL 175mm W 4.75mm               | <b>89160.3003</b> | 1        | Orthopedics / Shoulder |
| Convex rasp WL 175 mm W 4.75mm               | <b>89160.3002</b> | 1        | Orthopedics / Shoulder |
| Straight rasp WL 175mm W 4.75mm              | <b>89160.3005</b> | 1        | Orthopedics / Shoulder |
| Knife angled 15° WL 160mm W 4.5mm            | <b>89160.3015</b> | 1        | Orthopedics / Shoulder |
| Distally cutting knife WL 160mm W 4.5mm      | <b>89160.3001</b> | 1        | Orthopedics / Shoulder |
| Suture cutter Ø 5mm WL 200mm                 | <b>891603000</b>  | 1        | Orthopedics / Shoulder |
| Suture grasping forceps Ø 3.3mm              | <b>891303300</b>  | 1        | Orthopedics / Shoulder |
| Grasping forceps Ø 3.4mm                     | <b>8488.096</b>   | 1        | Orthopedics / Shoulder |
| Marking rod Ø 4.0mm, conical blunt           | <b>8863.75</b>    | 1        | Orthopedics / Shoulder |
| ENDOSPIKE shoulder suture instrument Ø 5.3mm | <b>891403000</b>  | 1        | Orthopedics / Shoulder |
| Also: Needles for suture forceps, sterile    | <b>491403000</b>  | 1        | Orthopedics / Shoulder |
| Perf. basket for shoulder arthroscopy        | <b>33012</b>      | 1        | Orthopedics / Shoulder |

**Endospike**

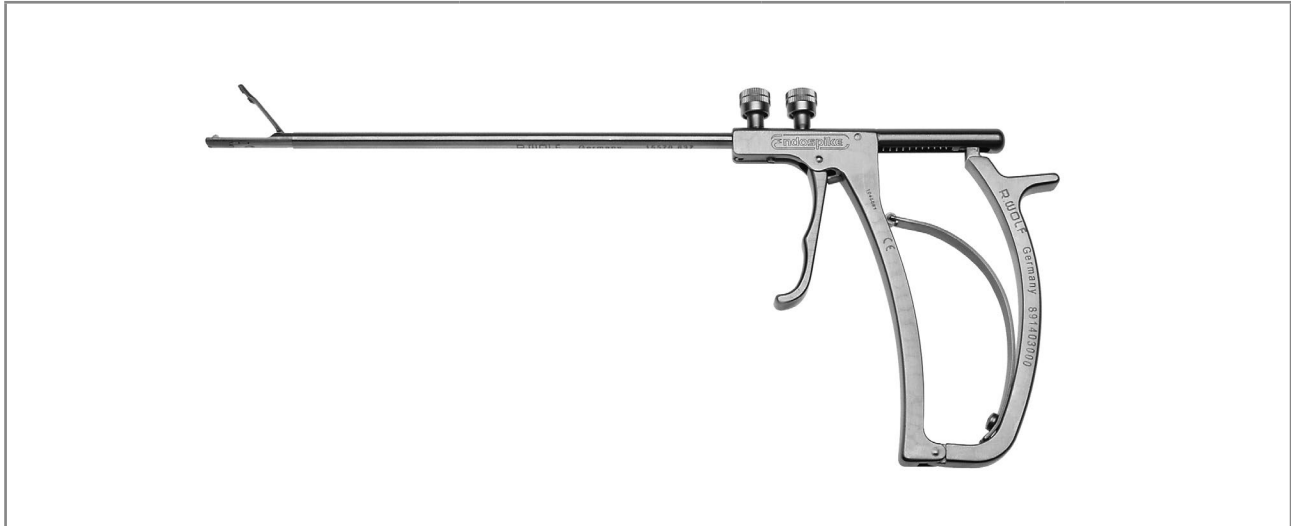

Shoulder Suture Instrument





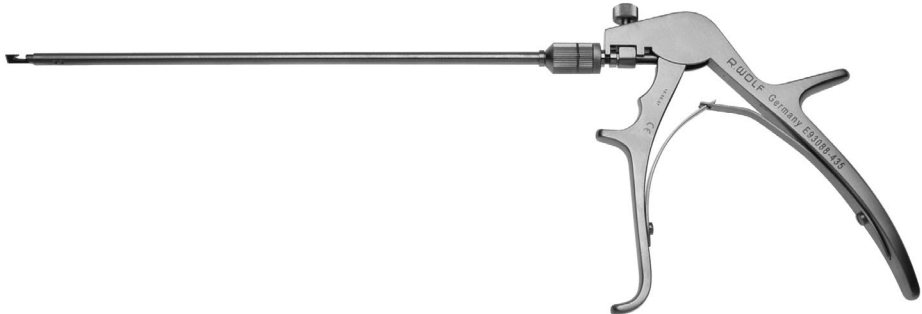

|  | Ø      | WL     | Product no.      |
|--|--------|--------|------------------|
| <p><b>ENDOSPIKE</b><br/>shoulder suture instrument Ø 5.3mm</p>  <p>with irrigation connector, can be dismantled</p> | 5.3 mm | 169 mm | <b>891403000</b> |
| Also:  |        |        |                  |
| <p><b>Needles for stitching forceps,</b><br/>sterile, disposable<br/>(PACK= 5 PCS)</p>   |        |        | <b>491403000</b> |



Shoulder  
2.4

## Suture Cutter / Suture Grasping Forceps

|   |        |        |                  |
|---|--------|--------|------------------|
|   | Ø      | WL     | Product no.      |
| <br><b>Suture cutter Ø 5mm WL 200mm</b><br>can be dismantled | 5.0 mm | 200 mm | <b>891603000</b> |

|   |        |        |                  |
|---|--------|--------|------------------|
|   | Ø      | WL     | Product no.      |
| <br><b>Suture grasping forceps Ø 3.3mm</b><br>jaw section straight, sheath straight  | 3.3 mm | 160 mm | <b>891303300</b> |
| <br><b>Suture grasping forceps Ø 3.3mm</b><br>straight jaw section, pointed          |        |        | <b>891303200</b> |
| <br><b>Suture grasping forceps Ø 3.3mm</b><br>jaw section curved 45° upward, pointed |        |        | <b>891303230</b> |

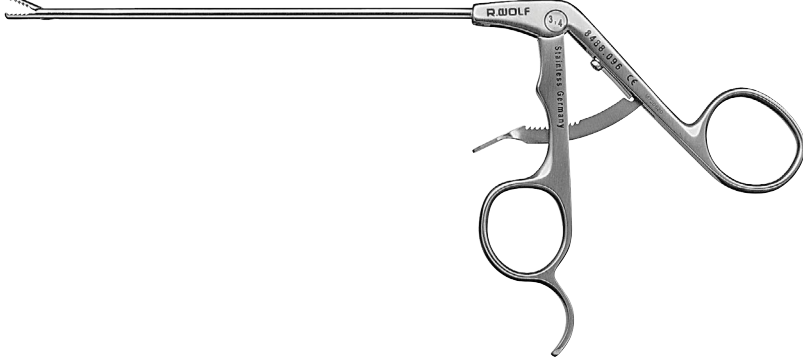
# Grasping Forceps

|    |        |        |                 |
|--|--------|--------|-----------------|
|  | Ø      | WL     | Product no.     |
| <br><b>Grasping forceps Ø 3.4mm</b><br><br>straight jaw section, serrated, handle with lock | 3.4 mm | 130 mm | <b>8488.096</b> |

Grasping forceps for holding and repositioning the rotator cuff.

Shoulder  
2.4

VII21 || Subject to modifications. Please note that some products may not be available in all countries. For more detailed information, please consult with your contact partner or directly with Richard Wolf GmbH.

# Hand Instruments

|   |   | WL     | Product no.       |
|---|---|--------|-------------------|
|   |   |        |                   |
| <b>Knot pusher WL 170 mm</b><br>                         | For applying and tightening slip knots in arthroscopically applied sutures  | 170 mm | <b>89150.3000</b> |
| <b>Suture catcher WL 160mm</b><br>                     | Hook eye for suture management  | 160 mm | <b>89150.3003</b> |
| <b>Distally cutting knife WL 160mm<br/>W 4.5mm</b><br> | For loosening soft tissue from the glenoid edge   | 160 mm | <b>89160.3001</b> |
| <b>Knife angled 15° WL 160mm<br/>W 4.5mm</b><br>       |   |        | <b>89160.3015</b> |
| <b>Convex rasp WL 175mm<br/>W 4.75mm</b><br><br>rough  | For arthroscopic "freshening" of the bone at the glenoid in Bankart and SLAP lesions<br><br>and of the greater tubercle in reconstruction of the rotator cuff | 175 mm | <b>89160.3002</b> |
| <b>Concave rasp WL 175mm W 4.75mm</b><br><br>rough     |   |        | <b>89160.3003</b> |
| <b>Straight rasp WL 175mm W 4.75mm</b><br><br>rough    |   |        | <b>89160.3005</b> |

# Sterilization Basket

## for Instruments Used in Shoulder Arthroscopy

Sterilization – storage – transport

| Illustration   | Description   | Product no.                                 |
|--|---|---|
|  <p><b>Perf. Basket for shoulder arthroscopy</b></p> <p>also:</p> <p><b>Fixing ring Ø 50.39mm</b></p> | <p>Holds: instrument set for shoulder arthroscopy, for sterilization (steam and low-temperature), storage and transport, with instrument holders, inner dimensions (wxhxd): 513x95x233mm, outer dimensions (wxhxd): 538x117x250mm</p> <p>for perforated basket for flexible endoscopes, for fixing instruments during machine reprocessing, sterilization (steam and low-temperature), storage and transport, Ø 50,39x3,53mm, PACK=10 PCS</p> | <p><b>33012</b></p> <p><b>643301261</b></p> |

Suitable for standard container

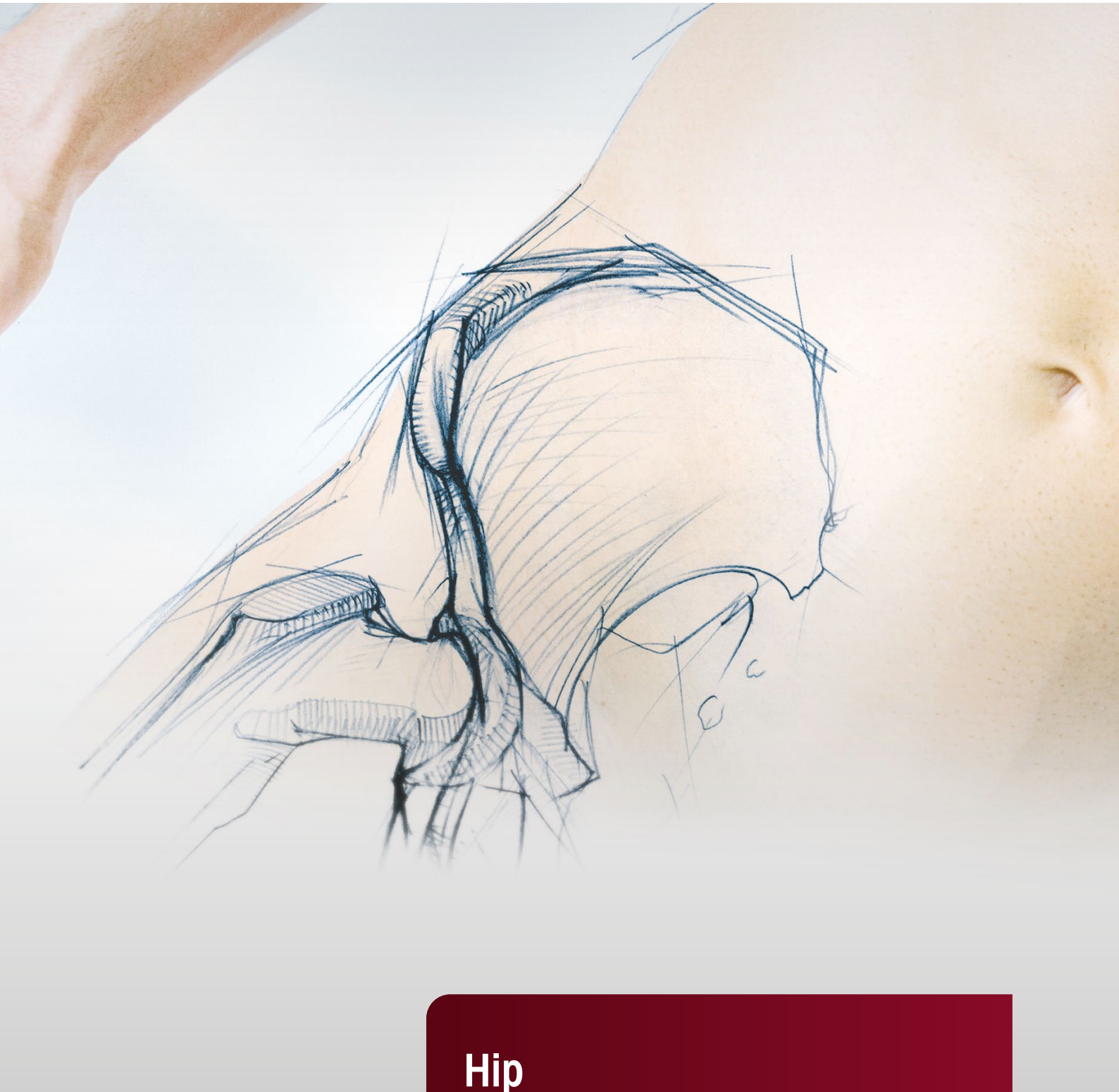

# Hip

## Hip

3.1

---

**Arthrolution Arthroscopes Overview**

---

3.2

**Telescopes and Sheaths**

---

3.3

**Access Instruments**

---

3.4

**Dilation Systems**

---

3.5

**Irrigation Cannula**

---

3.6

**Aiming Device**

---

3.7

**Instruments**

---



## Overview

| arthro<br><i>lution</i> |  |                               | Fingers, toes    | Hand             | Foot, elbow      |                  | Knee, shoulder, hip |
|-------------------------|--|-------------------------------|------------------|------------------|------------------|------------------|---------------------|
| Telescope Ø             |  |                               | 1.9 mm           | 2.4 mm           | 2.7 mm           |                  | 4.0 mm              |
| Telescopes              | 30°  | PANOVIEW telescope            | <b>8860453</b>   | <b>8871413</b>   | <b>8476.433</b>  | <b>8672.422</b>  | <b>8880.543</b>     |
|                         |  | PANOVIEW wide angle telescope |                  |                  |                  |                  | <b>8885.443</b>     |
|                         | 70°  | PANOVIEW telescope            |                  |                  |                  |                  | <b>8880.545</b>     |
|                         |  | PANOVIEW wide angle telescope |                  |                  |                  |                  | <b>8885.445</b>     |
| Sheath WL               |  |                               | 40 mm            | 60 mm            | 77.5 mm          | 145 mm           | 130 mm              |
| Sheaths                 | with 1 irrigation stopcock, fixed                    |                               | <b>891220124</b> | <b>891220132</b> |                  |                  |                     |
|                         | with 2 irrigation stopcocks, fixed                   |                               |                  |                  |                  |                  | <b>89121.0260</b>   |
|                         | with 1 irrigation stopcock, rotatable                |                               |                  |                  |                  | <b>891241141</b> |                     |
|                         | with 2 irrigation stopcocks, rotatable               |                               |                  | <b>891221232</b> | <b>891221241</b> | <b>891241241</b> | <b>89121.1260</b>   |
|                         | High-Flow with 1 irrigation stopcock, fixed          |                               | <b>891220128</b> |                  |                  |                  |                     |
|                         | High-Flow with 2 irrigation stopcocks, rotatable     |                               |                  | <b>891221235</b> |                  |                  | <b>89121.1263</b>   |
|                         | Small-caliber with 2 irrigation stopcocks, rotatable |                               |                  |                  |                  |                  | <b>891221255</b>    |
| Obturator               | blunt  |                               |                  |                  | <b>891222754</b> |                  | <b>89121.0544</b>   |
|                         | semi-blunt   |                               | <b>891221952</b> | <b>891222452</b> |                  |                  | <b>89121.0542</b>   |
|                         | conical blunt  |                               |                  |                  | <b>891222750</b> | <b>891242750</b> | <b>89121.0540</b>   |
|                         | sharp  |                               |                  |                  |                  | <b>891242761</b> | <b>89121.0640</b>   |
|                         | conical pointed                                      |                               | <b>891221962</b> | <b>891222462</b> | <b>891222762</b> |                  |                     |
| Sealing part for sheath |  |                               |                  |                  |                  | <b>891040000</b> |                     |

# COXARTIS

Telescope Ø 4 mm

for 4 mm arthroscopes

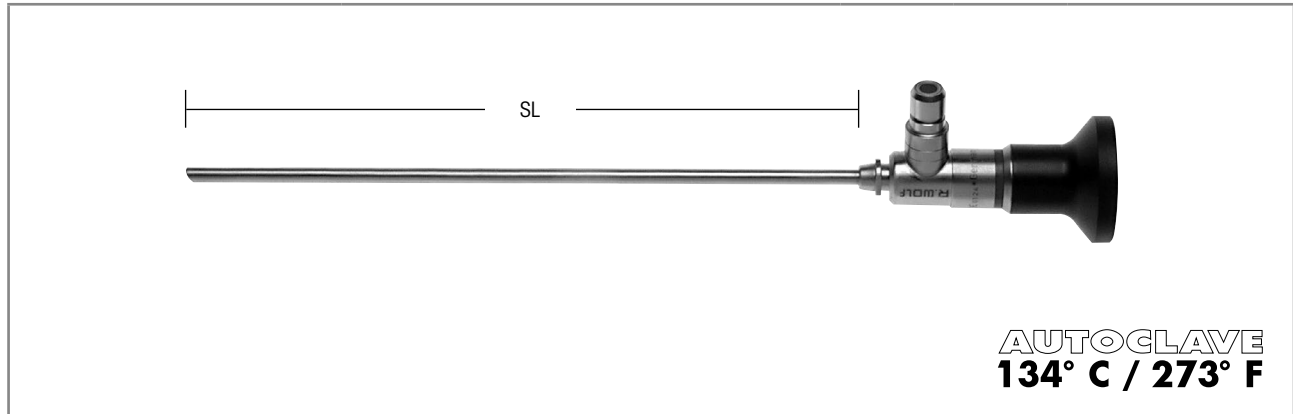

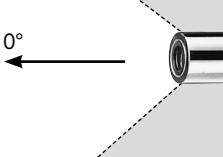
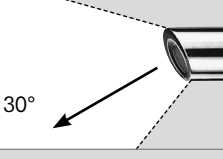
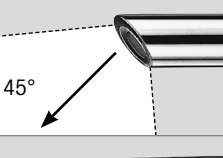
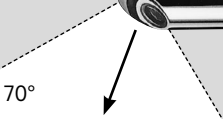

| Direction of view   |   | SL     | Ø      | Product no.     |
|---|---|--------|--------|-----------------|
|   | PANOVIEW<br>telescope 0° Ø 4mm SL 170mm   | 170 mm | 4.0 mm | <b>8880.541</b> |
|  | PANOVIEW<br>telescope 30° Ø 4mm SL 170mm  |        |        | <b>8880.543</b> |
|  | PANOVIEW<br>telescope 45° Ø 4mm SL 170mm  |        |        | <b>8880.544</b> |
|  | PANOVIEW<br>telescope 70° Ø 4mm SL 171 mm | 176 mm |        | <b>8880.547</b> |



| Recommended accessories   |                              | Product no.      |
|---|------------------------------|------------------|
| <b>Perf. basket for standard telescope 1</b>  | (L x B x H) 297 x 59 x 54 mm | <b>38015</b>     |
| <b>Fiber light cable bndl</b><br>Comprising:<br>Fiber light cable (80663523),<br>adapter, projector to light cable (8095.07), and<br>adapter, light cable to endoscope (809509) | Ø 3.5 mm, 2.3 m long         | <b>806635231</b> |

# COXARTIS

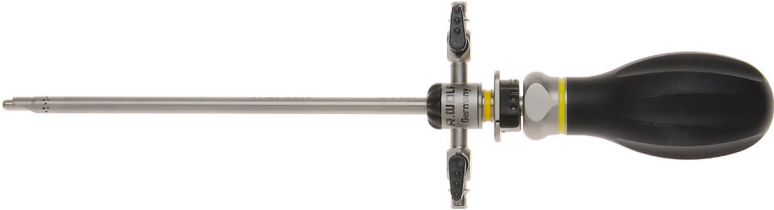
Sheath Ø 4 mm

for 4 mm arthroscopes

|  |   |   |        |                   |   |
|--|---|---|--------|-------------------|---|
|  |   |  |        |                   |   |
|  | 2 rotatable stopcocks   | Outer Ø   | WL     | Product no.       | Obturator for arthroscope<br>OD 6/6.3mm<br>cannulated, capacity 2mm |
| ArthroLution sheath for arthroscope OD 6mm with automatic click-lock mechanism     | ●   | 6.0 mm  | 145 mm | <b>8912312603</b> | <b>891234073</b>  |
| Also:<br>Sealing part for sheath   |  |   |        |                   | <b>89101.0000</b>   |

|  |   |   |         |        |   |  |
|---|---|---|---------|--------|---|--|
|   |   |   |         |        |  |  |
| For continuous irrigation<br>Comprising:  |   | 2 rotatable stopcocks   | Outer Ø | WL     | Product no.   | Obturator for arthroscope<br>OD 5.3/6 mm,<br>semi-blunt,<br>capacity 2mm |
| ArthroLution sheath and outer sheath  | ArthroLution sheath for arthroscope OD 5.3mm, with automatic click-lock mechanism |   | 5.3 mm  |        | <b>8912312533</b>   | <b>891234052</b>   |
|   | Outer sheath for arthroscope OD 6.3mm   | ●   | 6.3 mm  | 130 mm | <b>8912300633</b>   |  |
| Also:<br>Sealing part for sheath  |   |  |         |        |   | <b>89101.0000</b>  |

# COXARTIS

## Telescope and Sheath Systems

for 4 mm arthroscopes, extra long

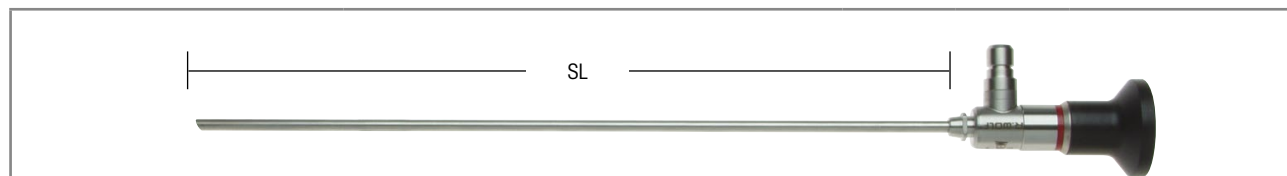

**AUTOCLAVE**  
**134° C / 273° F**

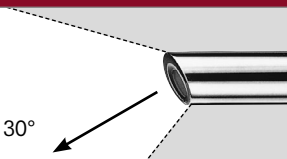
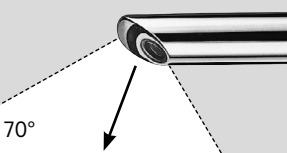
| Direction of view  |  | SL     | Ø      | Product no.      |
|--|--|--------|--------|------------------|
|   | PANOVIEW<br>telescope 30° Ø 4 mm SL 248 mm | 248 mm | 4.0 mm | <b>891134030</b> |
|  | PANOVIEW<br>telescope 70° Ø 4 mm SL 251 mm | 251 mm |        | <b>891134070</b> |

| Recommended accessories   |                              | Product no.      |
|---|------------------------------|------------------|
| <b>Perf. basket for standard telescope 1</b>  | (L x B x H) 297 x 59 x 54 mm | <b>38015</b>     |
| <b>Fiber light cable bndl</b><br>Comprising:<br>Fiber light cable (80663523),<br>adapter, projector to light cable (8095.07), and<br>adapter, light cable to endoscope (809509) | Ø 3.5 mm, 2.3 m long         | <b>806635231</b> |

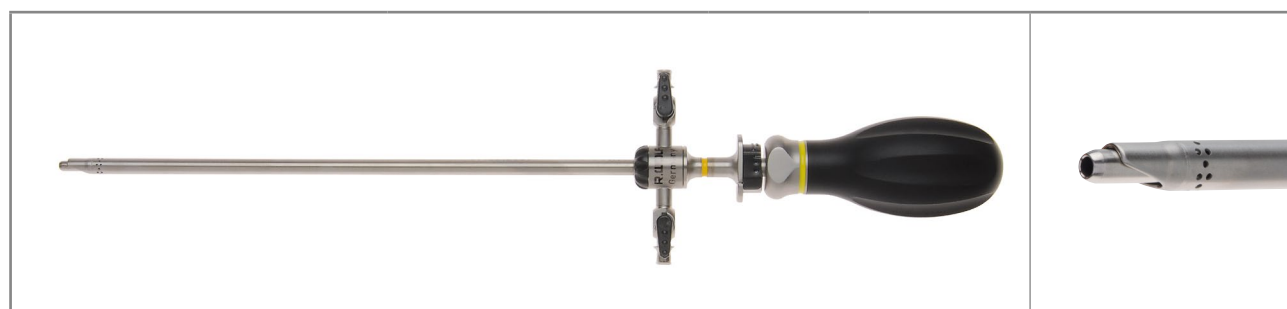

|  | 2 rotatable stopcocks   | Outer Ø | WL     | Product no.       | Obturator for arthroscope<br>OD 6 mm, cannulated,<br>capacity 2 mm |
|--|---|---------|--------|-------------------|--|
| ArthroLution<br><b>sheath for arthroscope OD 6mm,</b><br>with automatic click-lock mechanism | ●   | 6.0 mm  | 145 mm | <b>8912312607</b> | <b>891234077</b>   |
| Also:<br><b>Sealing part for sheath</b>  |  |         |        |                   | <b>89101.0000</b>  |

VII21 || Subject to modifications. Please note that some products may not be available in all countries. For more detailed information, please consult with your contact partner or directly with Richard Wolf GmbH.

# COXARTIS

## Access Instruments

Cannula for punction, guide wire, marking rod

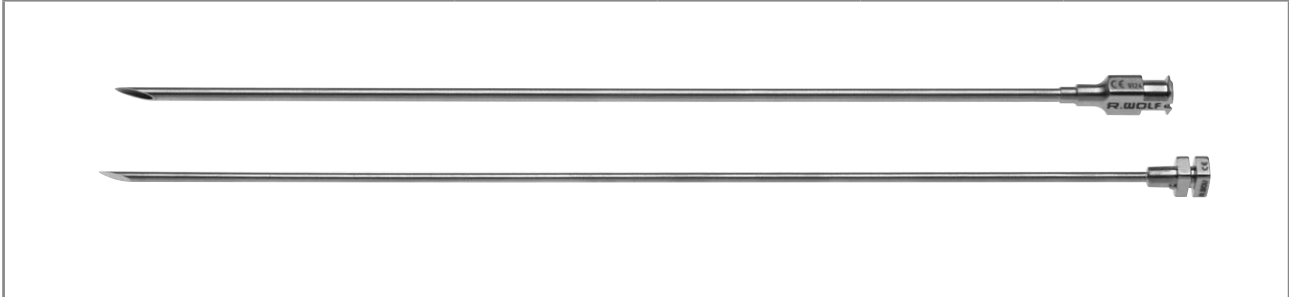

|  | Ø      | Capacity | WL     | Product no.      |
|--|--------|----------|--------|------------------|
| <b>Cannula for punction Ø 2.6/2mm WL 200mm</b><br>with internal needle,<br>(PACK= 2 PCS) | 2.6 mm | 2.0 mm   | 200 mm | <b>891732018</b> |



|  | Ø      | TL     | Product no.      |
|--|--------|--------|------------------|
| <b>Nitinol guide wire Ø 2mm</b><br>(PACK= 2 PCS) | 2.0 mm | 450 mm | <b>891534020</b> |

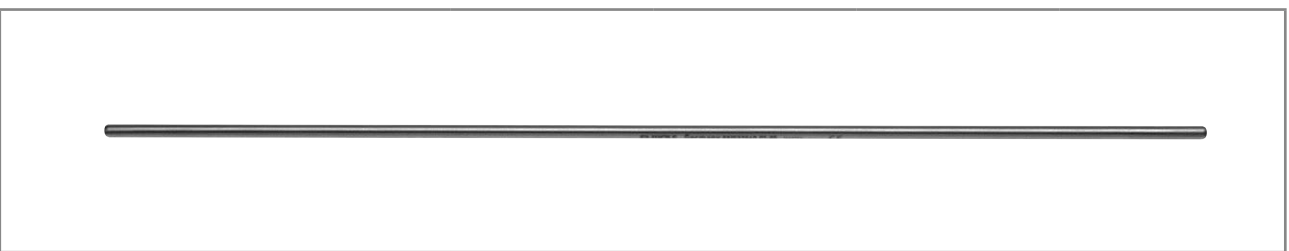

|   | Ø      | Capacity | TL     | Product no.      |
|---|--------|----------|--------|------------------|
| <b>Marking rod Ø 4.0mm</b><br>cannulated    | 4.0 mm | 2.25 mm  | 325 mm | <b>891532040</b> |
| <b>Marking rod Ø 4.0mm</b><br>conical blunt | 4.0 mm | -        | 325 mm | <b>8863.75</b>   |

V121 || Subject to modifications. Please note that some products may not be available in all countries. For more detailed information, please consult with your contact partner or directly with Richard Wolf GmbH.

# COXARTIS

## Access Instruments

### Guide tube







|  | Ø      | Capacity | WL     | Product no.      |
|--|--------|----------|--------|------------------|
| <b>Guide sheath slitted WL 120 mm SZ 7 mm</b><br>slotted | 2.6 mm | 2 mm     | 200 mm | <b>891237012</b> |
| <b>Obturator for guide tube</b><br>cannulated            |        |          | 142 mm | <b>891232070</b> |

# COXARTIS

## Access Instruments

### Dilation system

|  <p>891532050 / 891532070 / 891532090</p> <p style="text-align: right;">891530000</p> |              |        |          |        |                  |
|---|--------------|--------|----------|--------|------------------|
|   | Color coding | Ø      | Capacity | WL     | Product no.      |
| <b>Dilatator Ø 5mm WL 200mm</b><br><br>cannulated                                    | green        | 5.0 mm | 2.0 mm   | 200 mm | <b>891532050</b> |
| <b>Dilatator Ø 7mm WL 200mm</b><br><br>cannulated                                    | blue         | 7.0 mm |          |        | <b>891532070</b> |
| <b>Dilatator Ø 9mm WL 200mm</b><br><br>cannulated                                    | red          | 9.0 mm |          |        | <b>891532090</b> |
| <b>Handle attachment for dilators</b><br>  |              |        |          |        | <b>891530000</b> |

VI121 || Subject to modifications. Please note that some products may not be available in all countries. For more detailed information, please consult with your contact partner or directly with Richard Wolf GmbH.

# COXARTIS

## Irrigation Cannula



|                                       | Ø    | Capacity | WL     | Product no.      |
|---------------------------------------|------|----------|--------|------------------|
| Cannula for irrigation Ø 8mm WL 168mm | 8 mm | 7 mm     | 168 mm | <b>891737080</b> |

Hip  
3.5







# COXARTIS

## Aiming Device

VI121 || Subject to modifications. Please note that some products may not be available in all countries. For more detailed information, please consult with your contact partner or directly with Richard Wolf GmbH.





|   |  | Product no.      |
|---|--|------------------|
| <b>Aiming device bndl</b><br>Comprising:  | Hip alignment ARC (891240100),<br>Hip guide sleeve (891240200),<br>Guide attachment AD hip (891240300),<br>Rotatable irrigation ring hip (891240400) | <b>891240000</b> |
| <b>Hip alignment ARC</b><br>with adapter for rotatable irrigation ring                                  |   | 891240100        |
| <b>Hip guide sleeve</b><br>for connection to puncture cannula<br>891732018                              |    | 891240200        |
| <b>Guide attachment AD hip</b><br>for connection to guide sleeve  |   | 891240300        |
| <b>Rotatable irrigation ring hip</b><br>rotatable with 2 stopcocks and adapter<br>for alignment bracket |   | 891240400        |

Hip  
3.6

# COXARTIS

## Hook Probe / Banana Knife

|                                    |        |        |                  |
|--|--------|--------|------------------|
|  | Height | WL     | Product no.      |
| Hook probe WL 150mm H 4.5mm<br><br> | 4.5 mm | 150 mm | <b>891534515</b> |





|                              |        |                 |
|--|--------|-----------------|
|  | WL     | Product no.     |
| Banana knife WL 125mm<br><br> | 125 mm | <b>8436.251</b> |

|    |         |        |                   |
|--|---------|--------|-------------------|
|  | Width   | WL     | Product no.       |
| Convex rasp WL 175mm W 4.75mm<br><br>rough  | 4.75 mm | 175 mm | <b>89160.3002</b> |

# COXARTIS







## Curette and Microfractor



|  |   | Ø      | WL     | Product no.      |
|--|---|--------|--------|------------------|
| <b>Curette, square, Ø 4.5mm WL 170mm</b> |    | 4.5 mm | 170 mm | <b>891632245</b> |
| <b>Curette, square, Ø 5mm WL 170mm</b>   |    | 5.0 mm |        | <b>891632260</b> |
| <b>Curette, round, Ø 4.8mm WL 170mm</b>  |    | 4.8 mm |        | <b>891631255</b> |
| <b>Curette, round, Ø 6.3mm WL 170mm</b>  |  | 6.3 mm |        | <b>891631270</b> |

double-blade and curved upward







|                                   |   | Deflection   | WL     | Product no.      |
|-----------------------------------|---|--------------|--------|------------------|
| <b>Microfractor WL 170mm 15°</b>  |  | Curved 15°   | 170 mm | <b>891631521</b> |
| <b>Microfractor WL 170mm 30°</b>  |  | Curved 30°   |        | <b>891633021</b> |
| <b>Microfractor WL 170mm 45°</b>  |  | Curved 45°   |        | <b>891634521</b> |
| <b>Microfractor WL 170 mm 35°</b> |  | 35° S-shaped |        | <b>891633522</b> |
| <b>Microfractor WL 170mm 60°</b>  |  | Curved 60°   |        | <b>891636021</b> |
| <b>Microfractor WL 170mm 60°</b>  |  | 60° S-shaped |        | <b>891636022</b> |
| <b>Microfractor WL 170mm 80°</b>  |  | Curved 80°   |        | <b>891638021</b> |

VI121 || Subject to modifications. Please note that some products may not be available in all countries. For more detailed information, please consult with your contact partner or directly with Richard Wolf GmbH.

# COXARTIS

## PULSEShifter Microfractor / Grasping Forceps

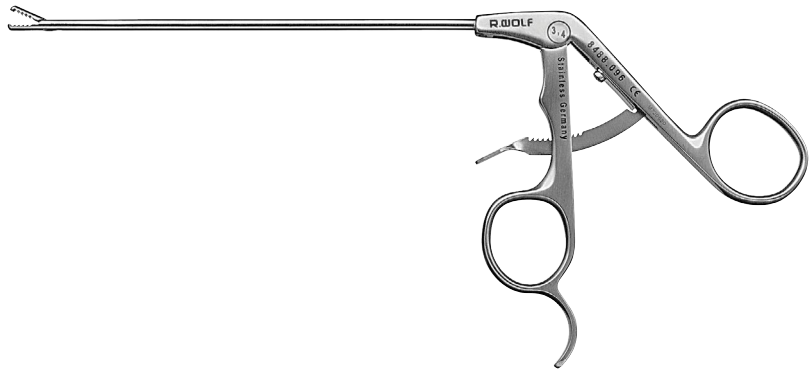







|   |                                      |               |                         |
|---|--------------------------------------|---------------|-------------------------|
|   |                                      | WL            | Product no.             |
| <p>PULSEShifter<br/>Microfractor WL 170 mm 45°</p>  | <p>curved 45°, can be dismantled</p> | <p>170 mm</p> | <p><b>891634530</b></p> |

|  |               |               |                        |             |
|--|---------------|---------------|------------------------|-------------|
|    |               | Ø             | WL                     | Product no. |
| <p>Grasping forceps Ø 3.4 mm</p>  <p>straight jaw section, serrated, handle with lock</p> | <p>3.4 mm</p> | <p>130 mm</p> | <p><b>8488.096</b></p> |             |



COXARTIS

arthro *line* Punch



| ARTHROline   | Jaw section (Height) | WL     | Straight | Curved to the left | Curved to the right | Sheath curved upward | Jaws curved upward | Product no. |
|--|----------------------|--------|----------|--------------------|---------------------|----------------------|--------------------|-------------|
| <p>Punch WL 180mm H 1.6mm</p>  <p>Sectional view: </p> | 1.6 mm               | 180 mm | ●        |                    |                     |                      | ●                  | 891432102   |
| <p>Punch WL 180mm H 1.6mm</p>  <p>Sectional view: </p> |                      |        | ●        |                    |                     | ●                    | 891432101          |             |
| <p>Punch WL 180mm H 1.6mm</p>  <p>Sectional view: </p> |                      |        | ●        |                    | ●                   | ●                    | 891432103          |             |
| <p>Punch WL 180mm H 1.6mm</p>  <p>Sectional view: </p> |                      |        | ●        | ●                  |                     |                      | 891432122          |             |

VI121 || Subject to modifications. Please note that some products may not be available in all countries. For more detailed information, please consult with your contact partner or directly with Richard Wolf GmbH.

| Spare part and accessory   |   | Product no.              |
|--|---|--------------------------|
| <p><b>Sterile adapter</b><br/>eyecup for replacing the endoscope under sterile conditions, locking mechanism</p>   |    | <p><b>8580.91</b></p>    |
| <p><b>Sealing part for sheath</b></p>  |    | <p><b>89101.0000</b></p> |
| <p><b>Irrigation ring with 1 stopcock</b></p>  |   | <p><b>150081761</b></p>  |
| <p><b>Irrigation ring with 2 stopcocks</b></p>   |   | <p><b>150081762</b></p>  |
| <p><b>Stopcock bndl cap 3.0mm</b><br/>(PACK= 5 PCS)</p>  |  | <p><b>896.0002</b></p>   |
| <p><b>Mounting ring</b></p>  |   | <p><b>15008.1704</b></p> |
| <p><b>Spare seal set</b><br/>Comprising:<br/>O-ring 9.25X 1.78 VMQ-70 coated (15364396)<br/>O-ring 7.65X 1.78 VMQ-70 coated (15364395)<br/>(PACK= 5 PCS)</p> |   | <p><b>15176.142</b></p>  |
| <p><b>Also:</b><br/><b>O-ring tool</b></p>   |   | <p><b>15106.230</b></p>  |



**Elbow / Foot**

## Elbow / Foot

4.1

---

**Arthrolution Arthroscopes Overview**

---

4.2

**Telescopes and Sheaths**

---

4.3

**Instruments – Drainage Cannulas / Hook Probes / Guide and Marking Rods /  
ARTHROline Punches / Scissors / Forceps**

---

4.4

**Instruments for Endoscopically Assisted Decompression of the Ulnar Nerve**

---



**arthro**  
*lution* Arthroscope

Overview

Elbow / Foot  
4.1

| arthro<br><i>lution</i> |  |                               | Fingers, toes    | Hand             | Foot, elbow      |                  | Knee,<br>shoulder, hip |
|-------------------------|--|-------------------------------|------------------|------------------|------------------|------------------|------------------------|
| Telescope Ø             |  |                               | 1.9 mm           | 2.4 mm           | 2.7 mm           |                  | 4.0 mm                 |
| Telescopes              | 30°  | PANOVIEW telescope            | <b>8860453</b>   | <b>8871413</b>   | <b>8476.433</b>  | <b>8672.422</b>  | <b>8880.543</b>        |
|                         |  | PANOVIEW wide angle telescope |                  |                  |                  |                  | <b>8885.443</b>        |
|                         | 70°  | PANOVIEW telescope            |                  |                  |                  |                  | <b>8880.545</b>        |
|                         |  | PANOVIEW wide angle telescope |                  |                  |                  |                  | <b>8885.445</b>        |
| Sheath WL               |  |                               | 40 mm            | 60 mm            | 77.5 mm          | 145 mm           | 130 mm                 |
| Sheaths                 | with 1 irrigation stopcock, fixed                    |                               | <b>891220124</b> | <b>891220132</b> |                  |                  |                        |
|                         | with 2 irrigation stopcocks, fixed                   |                               |                  |                  |                  |                  | <b>89121.0260</b>      |
|                         | with 1 irrigation stopcock, rotatable                |                               |                  |                  |                  | <b>891241141</b> |                        |
|                         | with 2 irrigation stopcocks, rotatable               |                               |                  | <b>891221232</b> | <b>891221241</b> | <b>891241241</b> | <b>89121.1260</b>      |
|                         | High-Flow with 1 irrigation stopcock, fixed          |                               | <b>891220128</b> |                  |                  |                  |                        |
|                         | High-Flow with 2 irrigation stopcocks, rotatable     |                               |                  | <b>891221235</b> |                  |                  | <b>89121.1263</b>      |
|                         | Small-caliber with 2 irrigation stopcocks, rotatable |                               |                  |                  |                  |                  | <b>891221255</b>       |
| Obturator               | blunt  |                               |                  |                  | <b>891222754</b> |                  | <b>89121.0544</b>      |
|                         | semi-blunt   |                               | <b>891221952</b> | <b>891222452</b> |                  |                  | <b>89121.0542</b>      |
|                         | conical blunt  |                               |                  |                  | <b>891222750</b> | <b>891242750</b> | <b>89121.0540</b>      |
|                         | sharp  |                               |                  |                  |                  | <b>891242761</b> | <b>89121.0640</b>      |
|                         | conical pointed                                      |                               | <b>891221962</b> | <b>891222462</b> | <b>891222762</b> |                  |                        |
| Sealing part for sheath |  |                               |                  |                  |                  | <b>891040000</b> |                        |

VII/21 || Subject to modifications. Please note that some products may not be available in all countries. For more detailed information, please consult with your contact partner or directly with Richard Wolf GmbH.

## Telescope 2.7 mm for Standard Arthroscope

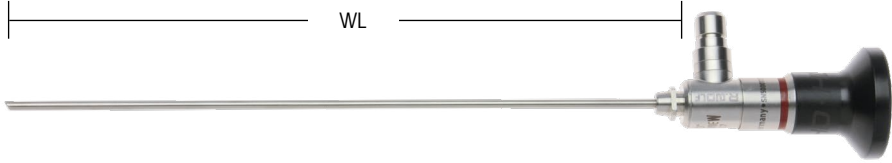

**AUTOCLAVE**  
**134° C / 273° F**

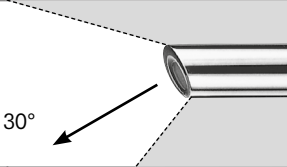
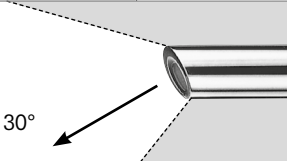
| Direction of view   |  | WL     | Ø      | Product no.     |
|---|--|--------|--------|-----------------|
|   | PANOVIEW PLUS HD<br>telescope 30° Ø 2.7mm WL 103mm | 103 mm | 2.7 mm | <b>8476.433</b> |
|  | PANOVIEW<br>TELESCOPE 30° Ø 2.7mm WL 182mm         | 182 mm |        | <b>8672.422</b> |

| Recommended accessories   |                              | Product no.      |
|---|------------------------------|------------------|
| <b>Perf. basket for standard telescope 1</b>  | (L x B x H) 297 x 59 x 54 mm | <b>38015</b>     |
| <b>Fiber light cable bndl</b><br>Comprising:<br>Fiber light cable (80663523),<br>adapter, projector to light cable (8095.07), and<br>adapter, light cable to endoscope (809509) | Ø 3.5 mm, 2.3 m long         | <b>806635231</b> |

## Telescope 4.0 mm for Standard Arthroscope

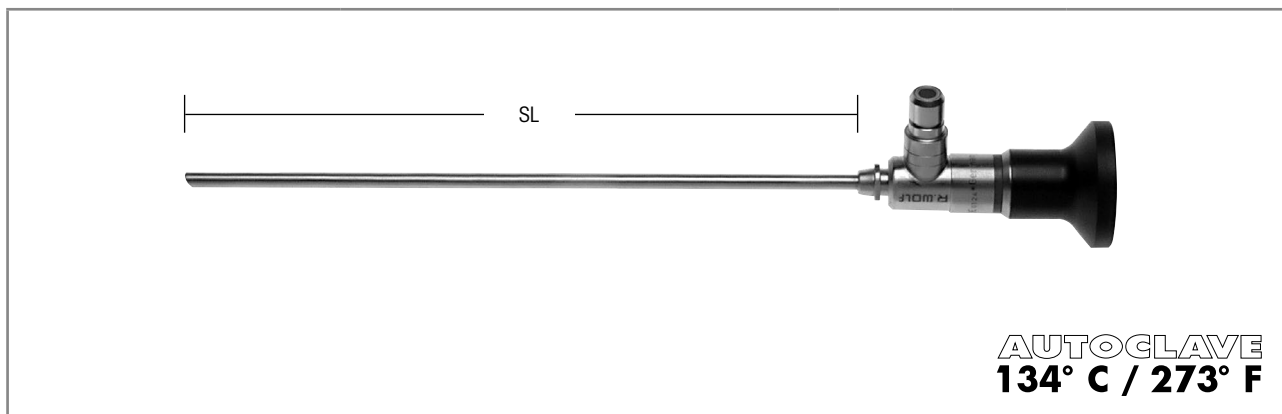

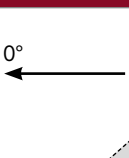
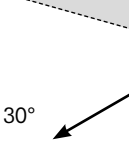
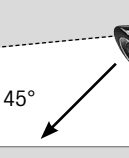
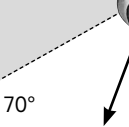
| Direction of view   |  | SL     | Ø      | Product no.     |
|---|--|--------|--------|-----------------|
|   | PANOVIEW<br>telescope 0° Ø 4mm SL 170mm  | 170 mm | 4.0 mm | <b>8880.541</b> |
|  | PANOVIEW<br>telescope 30° Ø 4mm SL 170mm |        |        | <b>8880.543</b> |
|  | PANOVIEW<br>telescope 45° Ø 4mm SL 170mm |        |        | <b>8880.544</b> |
|  | PANOVIEW<br>telescope 70° Ø 4mm SL 176mm | 176 mm |        | <b>8880.545</b> |

| Recommended accessories   |                              | Product no.      |
|---|------------------------------|------------------|
| <b>Perf. basket for standard telescope 1</b>  | (L x B x H) 297 x 59 x 54 mm | <b>38015</b>     |
| <b>Fiber light cable bndl</b><br>Comprising:<br>Fiber light cable (80663523),<br>adapter, projector to light cable (8095.07), and<br>adapter, light cable to endoscope (809509) | Ø 3.5 mm, 2.3 m long         | <b>806635231</b> |

VI121 || Subject to modifications. Please note that some products may not be available in all countries. For more detailed information, please consult with your contact partner or directly with Richard Wolf GmbH.

**arthro** *lution* Sheath for Arthroscope

with automatic click-lock mechanism

Elbow / Foot



4.2

|   |         |         |                  |  |   |   |
|---|---------|---------|------------------|--|---|---|
|  |         |         |                  |  |  |  |
|   |         |         |                  |  |   |   |
| 2 rotatable stop-cocks  | Outer ø | WL      | Product no.      |  |   |   |
| ●   | 4.1 mm  | 77.5 mm | <b>891221241</b> | <b>891222754</b>   | <b>891222750</b>  | <b>891222762</b>  |

| Recommended accessories               |   | Product no.       |
|---------------------------------------|---|-------------------|
| Sealing part for sheath               |  | <b>89101.0000</b> |
| Marking rod ø 4.0 mm, TL 325 mm       | conical blunt   | <b>8863.75</b>    |
| <b>Spare parts</b>                    |   |                   |
| Irrigation ring with 1 stopcock       |   | <b>150081761</b>  |
| Irrigation ring with 2 stopcocks      |   | <b>150081762</b>  |
| Stopcock bndl cap 3.0mm (PACK= 5 PCS) |   | <b>896.0002</b>   |
| Also: Disassembly tool                |   | <b>38310.0001</b> |
| Mounting ring                         |   | <b>15008.1704</b> |
| Spare seal set (O-rings)              | Comprising:<br>O-ring, small (PACK= 5 PCS)<br>O-ring, large (PACK= 5 PCS)           | <b>15176.142</b>  |
| Also: O-ring tool (disassembly tool)  |   | <b>15106.230</b>  |

**arthro** *lution* Sheath for Arthroscope

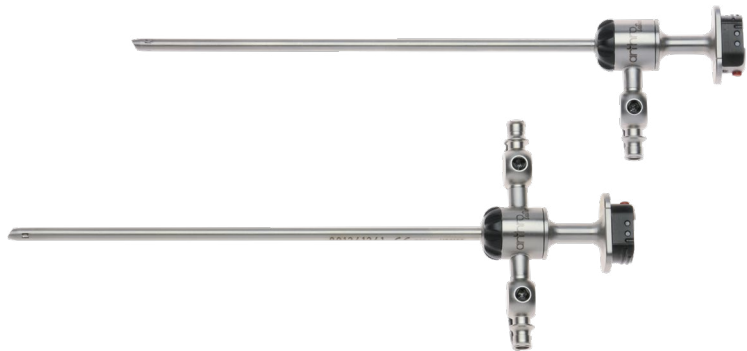
with automatic click-lock mechanism

|  |                       |         |        |             |  |  |
|---|-----------------------|---------|--------|-------------|---|---|
| Sheath for arthroscope OD 4.1 mm  |                       |         |        |             | Obturator for arthroscope OD 4.1 mm sharp, with slanted tip                         | Obturator for arthroscope OD 4.1 mm conical blunt                                   |
| 1 rotatable stopcock  | 2 rotatable stopcocks | Outer Ø | WL     | Product no. |   |   |
| ●   |                       | 4.1 mm  | 145 mm | 891241141   | 891242761   | 891242750   |
|   | ●                     |         |        | 891241241   |   |   |

Elbow / Foot

4.2

| Recommended accessories               |   | Product no. |
|---------------------------------------|---|-------------|
| Sealing part for sheath               |  | 891040000   |
| Marking rod Ø 2.7 mm, TL 250 mm       | conical pointed   | 891242725   |
| <b>Spare parts</b>                    |   |             |
| Irrigation ring with 1 stopcock       |   | 150081761   |
| Irrigation ring with 2 stopcocks      |   | 150081762   |
| Stopcock bndl cap 3.0mm (PACK= 5 PCS) |   | 896.0002    |
| Also: Disassembly tool                |   | 38310.0001  |
| Mounting ring                         |   | 15008.1704  |
| Spare seal set (O-rings)              | Comprising:<br>O-ring, small (PACK= 5 PCS)<br>O-ring, large (PACK= 5 PCS)           | 15176.142   |
| Also: O-ring tool (disassembly tool)  |   | 15106.230   |





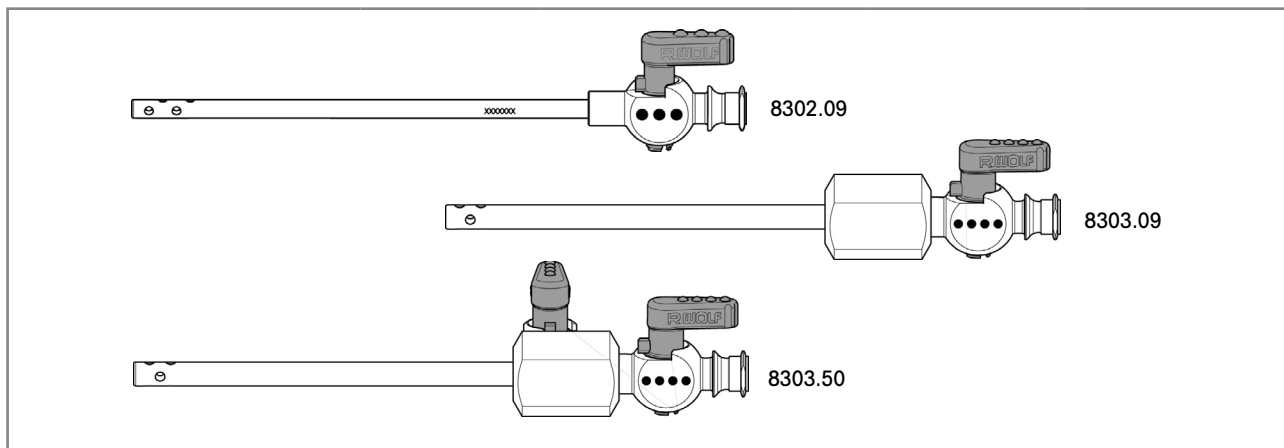

VI121 || Subject to modifications. Please note that some products may not be available in all countries. For more detailed information, please consult with your contact partner or directly with Richard Wolf GmbH.

# Drainage Cannula Ø 2.3 mm / 3.7 mm

Elbow / Foot









4.3











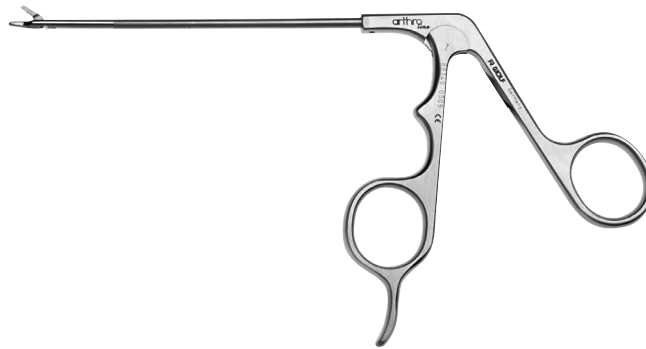

| Drainage for cannula and obturator   |   | Capacity | Ø            | WL      | Product no.     |
|--|---|----------|--------------|---------|-----------------|
| Drainage for cannula Ø 3.2mm<br>WL 80mm<br>with 1 insufflation stopcock    |  | 2.3 mm   | 3.2 mm       | 80 mm   | <b>8302.09</b>  |
| Drainage for cannula Ø 4.5mm<br>WL 71.5mm<br>with 1 insufflation stopcock  |  | 3.7 mm   | 4.5 mm       | 71.5 mm | <b>8303.09</b>  |
| Drainage for cannula Ø 4.5mm<br>WL 71.5mm<br>with 2 insufflation stopcocks |  | 3.7 mm   | 4.5 mm       | 71.5 mm | <b>8303.50</b>  |
| Obturator for cannula OD 3.2mm<br>sharp, with slanted tip                  |  | -        | 2.3 mm       | 103 mm  | <b>8302.101</b> |
| Obturator for cannula OD 3.2mm<br>conical blunt tip                        |  | -        | 2.3 mm       | 103 mm  | <b>8302.11</b>  |
| Obturator for cannula OD 4.5mm<br>sharp, with pyramid-shaped tip           |  | -        | 4.5 mm       | 115 mm  | <b>8303.10</b>  |
| Obturator for cannula OD 4.4mm<br>conical blunt tip                        |  | -        | 4.4 mm       | 115 mm  | <b>8303.11</b>  |
| Also:  |   |          |              |         |                 |
| Silicone tube<br>with Luer fitting 886.00                                  | for Drainage for cannula<br>8302.09   |          | Length 2.0 m |         | <b>8302.90</b>  |
| Silicone tube<br>with Luer fitting 886.01                                  | for Drainage for cannula<br>8303.09 / 50  |          |              |         | <b>8303.90</b>  |

VII.21 || Subject to modifications. Please note that some products may not be available in all countries. For more detailed information, please consult with your contact partner or directly with Richard Wolf GmbH.

## Hook Probe / Marking Rod

|  |          |           |                    |
|--|----------|-----------|--------------------|
|    |          |           |                    |
|  | <b>H</b> | <b>WL</b> | <b>Product no.</b> |
| <b>Hook probe WL 115mm H 7mm, graduated</b><br>   | 7.0 mm   | 115 mm    | <b>8399.901</b>    |
| <b>Hook probe WL 115mm H 4.5mm, graduated</b><br> | 4.5 mm   |           | <b>8399.95</b>     |
|    |          |           |                    |
|  | <b>Ø</b> | <b>TL</b> | <b>Product no.</b> |
| <b>Hook probe TL 228 mm SZ 4.4mm</b><br>        | 4.4 mm   | 228 mm    | <b>8863.80</b>     |
|    |          |           |                    |
| 8863.75  |          |           |                    |
|    |          |           |                    |
| 891242725  |          |           |                    |
|  | <b>Ø</b> | <b>TL</b> | <b>Product no.</b> |
| <b>Marking rod Ø 4.0mm conical blunt</b><br>    | 4.0 mm   | 325 mm    | <b>8863.75</b>     |
| <b>Marking rod Ø 2.7mm conical pointed</b><br>  | 2.7 mm   | 250 mm    | <b>891242725</b>   |









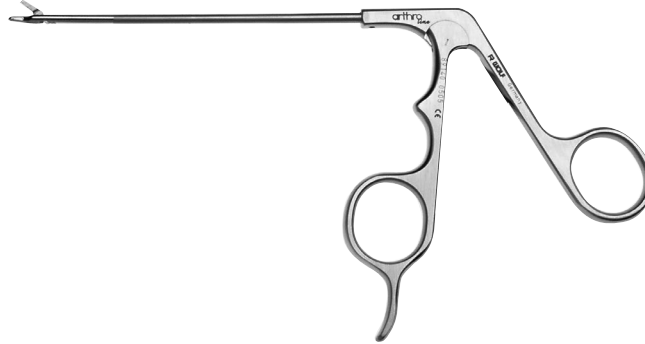





| ARTHROline   | Jaw section<br>(Height x width) | Cut width | WL     | Straight     | Curved to<br>the left | Sheath<br>curved<br>upward | Jaw section curved<br>upward | Product no.       |                   |                   |
|--|---------------------------------|-----------|--------|--------------|-----------------------|----------------------------|------------------------------|-------------------|-------------------|-------------------|
| <b>Punch W 4.6 mm H 1.6 mm</b><br>movable jaw section serrated<br><br>Sectional view:  | 1.6 x 4.6 mm                    | 3.3 mm    | 120 mm | ●            |                       |                            |                              | <b>89140.0105</b> |                   |                   |
| <b>Punch W 4.6 mm H 1.6 mm</b><br>movable jaw section serrated<br><br>Sectional view:  |                                 |           |        |              |                       |                            | ●                            | <b>89140.0102</b> |                   |                   |
| <b>Punch W 4.6 mm H 1.6 mm</b><br>movable jaw section serrated<br><br>Sectional view:  |                                 |           |        |              |                       |                            |                              | ●                 | <b>89140.0122</b> |                   |
| <b>Punch W 5.5 mm H 1.6 mm</b><br>movable jaw section serrated<br><br>Sectional view:  |                                 |           |        | 1.6 x 5.5 mm |                       |                            |                              | ●                 | ●                 | <b>89140.0101</b> |
| <b>Punch W 5.5 mm H 1.6 mm</b><br>movable jaw section serrated<br><br>Sectional view:  |                                 |           |        |              |                       |                            |                              |                   |                   | ●                 |









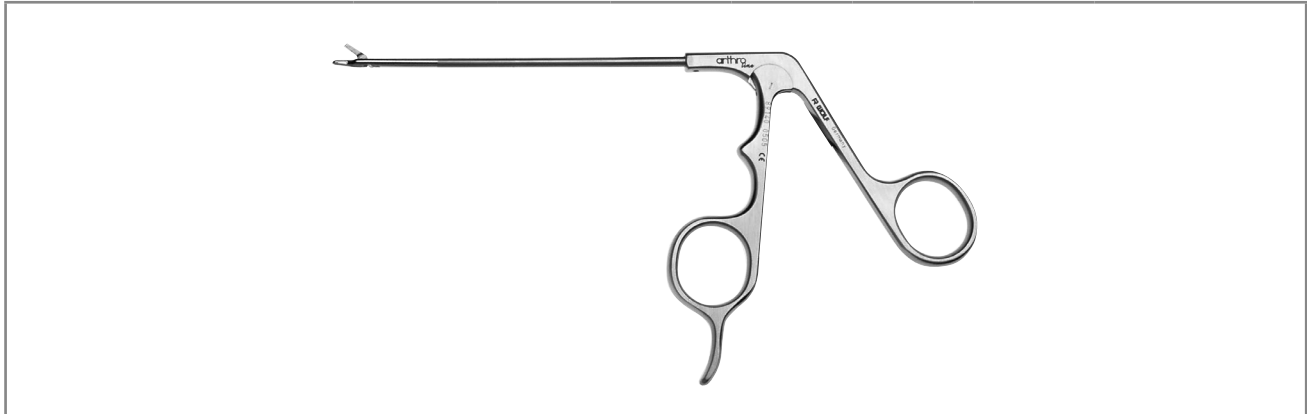

**arthro**  
*line* Hook Punch / Basket Punch



| ARTHROline   | Jaw section<br>(Height x width) | Cut width | WL     | Straight | Jaw section curved upward | Product no. |
|--|---------------------------------|-----------|--------|----------|---------------------------|-------------|
| <b>Hook punch W 3mm H 1.6mm</b><br><br>Sectional view:           | 1.6 x 3.0 mm                    | 1.8 mm    | 120 mm | ●        |                           | 89140.0205  |
| <b>Hook punch W 3mm H 1.6mm</b><br><br>Sectional view:           |                                 |           |        | ●        | 89140.0202                |             |
| <b>Basket punch W 6.5mm H 2.1mm oval</b><br><br>Sectional view:  | 2.1 x 6.5 mm                    | 4.5 mm    |        | ●        |                           | 89140.0305  |
| <b>Basket punch W 6.5mm H 2.1mm oval</b><br><br>Sectional view:  |                                 |           |        | ●        | 89140.0302                |             |
| <b>Hook punch W 4mm H 2.1mm</b><br><br>Sectional view:           | 2.1 x 4.0 mm                    | 2.1 mm    |        | ●        |                           | 89140.0405  |
| <b>Hook punch W 4 mm H 2.1mm</b><br><br>Sectional view:          |                                 |           |        | ●        | 89140.0402                |             |

**arthro**  
*line* Punch / Scissors Punch



| ARTHROline  | Jaw section (Height x width) | Cut width | WL     | Straight | Retrograde cutting | Jaw section curved upward | Product no.       |
|---|------------------------------|-----------|--------|----------|--------------------|---------------------------|-------------------|
| <b>Scissors punch W 2.4mm H 2.1 mm</b><br><br>Sectional view:               | 2.1 x 2.4 mm                 | 0.9 mm    | 120 mm | ●        |                    |                           | <b>89140.0505</b> |
| <b>Scissors punch W 2.4mm H 2.1 mm</b><br><br>Sectional view:               |                              |           |        |          | ●                  |                           | <b>89140.0502</b> |
| <b>Punch W 5.7mm H 4mm retrograde left-cutting</b><br><br>Sectional view:   | 4.0 x 5.7 mm                 | 2.3 mm    |        | ●        | left               |                           | <b>89140.0605</b> |
| <b>Punch W 5.7mm H 4mm retrograde right-cutting</b><br><br>Sectional view:  |                              |           |        | ●        | right              |                           | <b>89140.0602</b> |

## Suction Punch with Integrated Suction Channel

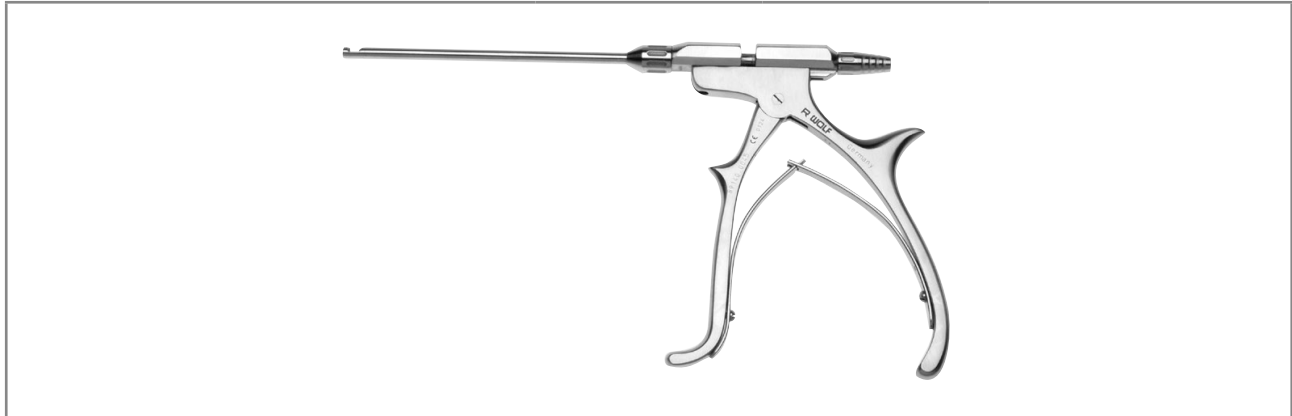





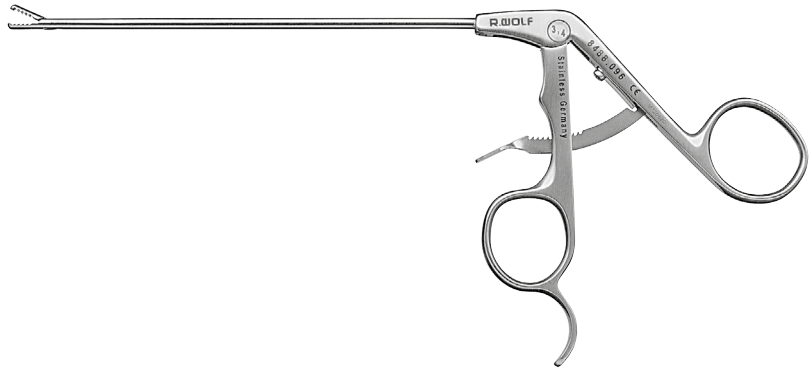

|  | Ø      | WL     | Product no.       |
|--|--------|--------|-------------------|
| <p><b>Suction punch Ø 2.7 mm</b><br/>with integrated suction channel</p>  | 2.7 mm | 110 mm | <b>89140.0027</b> |

## Grasping Forceps / Miniature Forceps

Elbow / Foot

4.3







|   |        |        |                 |
|---|--------|--------|-----------------|
|   | Ø      | WL     | Product no.     |
| <b>Grasping forceps Ø 3.4mm</b><br>straight jaw section, serrated, handle with lock<br> | 3.4 mm | 130 mm | <b>8488.096</b> |

|    |          |        |                 |
|--|----------|--------|-----------------|
| With overload protection and irrigation connector  | Sheath Ø | WL     | Product no.     |
| <b>Miniature forceps Ø 2.7mm</b><br><br>with double spoon jaw | 2.7 mm   | 110 mm | <b>8486.614</b> |
| <b>Miniature grasping forceps Ø 2.7mm</b><br>                 |          |        | <b>8486.624</b> |
| <b>Hook punch Ø 2.7mm</b><br>                                 |          |        | <b>8486.604</b> |

VII/21 || Subject to modifications. Please note that some products may not be available in all countries. For more detailed information, please consult with your contact partner or directly with Richard Wolf GmbH.

## Hook Punch / Punch







|   | Sheath<br>Ø | WL     | Jaw<br>section<br>(Height x<br>width) | Cut<br>width | Straight | Curved<br>to the<br>left | Curved<br>to the<br>right | Sheath<br>curved<br>15°<br>upward | Jaw<br>section<br>curved<br>15°<br>upward | Product no. |   |          |          |
|---|-------------|--------|---------------------------------------|--------------|----------|--------------------------|---------------------------|-----------------------------------|---|-------------|---|----------|----------|
| <b>Hook punch Ø 3,4mm<br/>with shovel</b>   | 3,4 mm      | 130 mm | 3,4 x 3,4<br>mm                       | 1,6 mm       | ●        |                          |                           |                                   |   | 8488.951    |   |          |          |
|                  |             |        |                                       |              |          | ●                        |                           |                                   |   |             |   | 8488.952 |          |
| Sectional view:  |             |        |                                       |              |          |                          |                           |                                   |   | ●           |   |          | 8488.953 |
|   |             |        |                                       |              |          |                          |                           |                                   |   |             | ● |          | 8488.954 |
| <b>Hook punch Ø 3.4mm<br/>movable jaw section<br/>serrated</b>                                      | 3,4 mm      | 130 mm | 3,4 x 3,4<br>mm                       | 1,6 mm       | ●        |                          |                           |                                   |   | 8488.02     |   |          |          |
|                  |             |        |                                       |              |          |                          |                           |                                   |   |             | ● |          | 8488.025 |
| <b>Hook punch Ø 3.4mm<br/>serrated</b>  | 3,4 mm      | 130 mm | 1,93 x<br>3,9 mm                      | 2,7 mm       | ●        |                          |                           |                                   |   | 8488.121    |   |          |          |
|                  |             |        |                                       |              |          |                          |                           |                                   |   |             |   | ●        | 8488.063 |
| <b>Hook punch Ø 4.5mm<br/>with shovel, serrated</b>   | 4,5 mm      |        | 1,73 x<br>5,4 mm                      | 3,4 mm       |          |                          |                           |                                   |   | 8489.063    |   |          |          |
|                  |             |        |                                       |              |          |                          |                           |                                   |   |             |   |          |          |
| Sectional view:  |             |        |                                       |              |          |                          |                           |                                   |   |             |   |          |          |

## Punch / Double Spoon Forceps

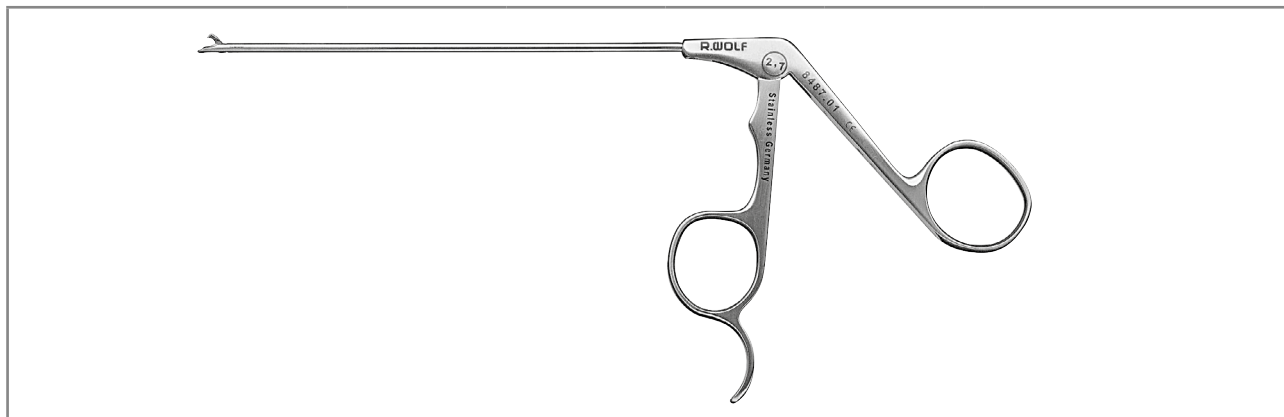
Elbow / Foot

4.3



|   | Jaw section<br>(Height x width) | Deflection   | Cut width | WL     | Product no.     |
|---|---------------------------------|--------------|-----------|--------|-----------------|
| <b>Punch Ø 3.4mm</b><br>front- and side-cutting<br><br><br>Sectional view:  | 2.2 x 5.3 mm                    | 90°<br>left  | 3.4 mm    | 130 mm | <b>8404.017</b> |
|   |                                 | 90°<br>right |           |        | <b>8404.018</b> |
| <b>Hook punch with shovel</b><br>Ø 3.4mm<br><br><br>Sectional view:         | 2.1 x 2.0 mm                    | 45°<br>left  | 1.7 mm    |        | <b>8404.71*</b> |
|   |                                 | 45°<br>right |           |        | <b>8404.81*</b> |

\* particularly suitable for lateral cutting and smoothing

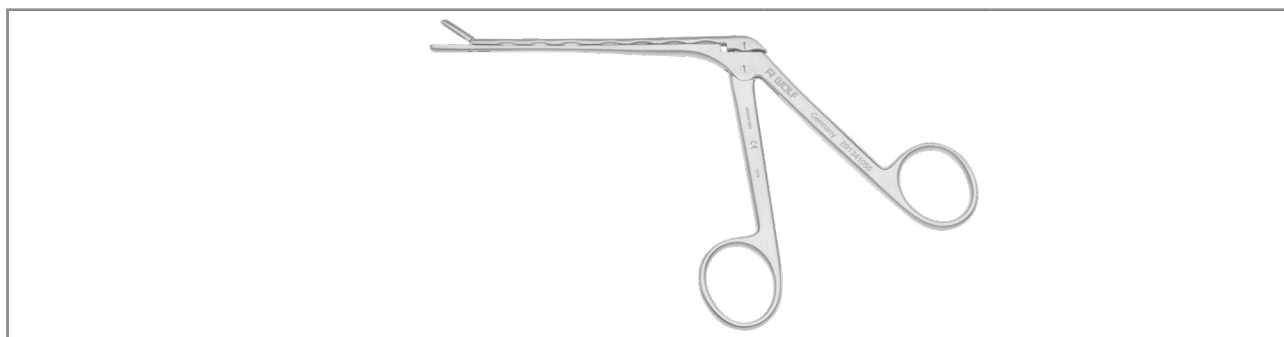



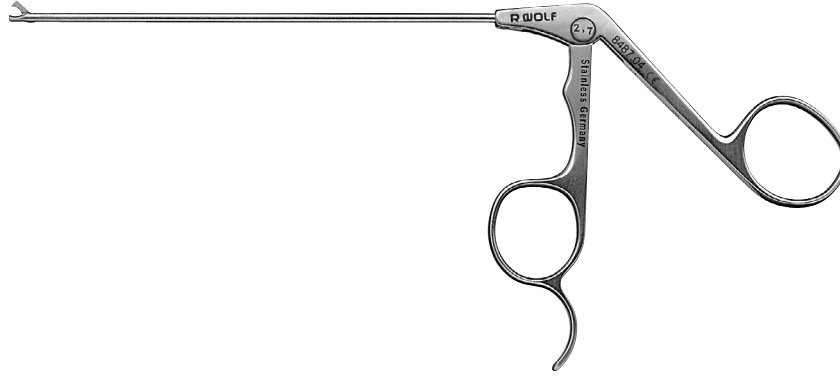

|  | Jaw section<br>(Height x width) | WL     | Product no.      |
|--|---------------------------------|--------|------------------|
| <b>Double spoon forceps W 3.1mm H 4.6mm</b><br>wave-shaped sheath<br><br> | 4.6 x 3.1 mm                    | 105 mm | <b>891341055</b> |

VII.21 || Subject to modifications. Please note that some products may not be available in all countries. For more detailed information, please consult with your contact partner or directly with Richard Wolf GmbH.



# Hook Scissors



|   | WL     | Straight jaw section   | Straight sheath | Sheath curved to the left | Sheath curved to the right | Product no.     |                 |
|---|--------|------------------------|-----------------|---------------------------|----------------------------|-----------------|-----------------|
| <b>Hook scissors Ø 2.7mm</b><br>   | 130 mm | ●                      | ●               |                           |                            | <b>8487.04</b>  |                 |
| <b>Hook scissors Ø 3.4mm</b><br>   |        | ●                      | ●               |                           |                            | <b>8488.04</b>  |                 |
| <b>Micro scissors Ø 3.4mm</b><br><br>Sectional view:  |        | ●                      |                 | ●                         |                            | <b>8488.041</b> |                 |
|   |        | ●                      |                 |                           | ●                          |                 | <b>8488.042</b> |
|   |        | ●                      |                 | ●                         |                            |                 | <b>8488.052</b> |
|   |        | ●                      |                 |                           | ●                          |                 | <b>8488.053</b> |
|   | WL     | Jaw section deflection | Straight sheath |                           | Product no.                |                 |                 |
| <b>Hook scissors Ø 3.4mm</b><br>   | 130 mm | 45° left               |                 | ●                         | <b>8404.52</b>             |                 |                 |
|   |        | 45° right              |                 | ●                         | <b>8404.62</b>             |                 |                 |

Hand Instruments  
Curette / Microfractor



|                                    |   | Deflection | WL    | Product no.      |
|------------------------------------|---|------------|-------|------------------|
| <b>Microfractor</b><br>WL 65mm 30° |    | Curved 30° | 65 mm | <b>891643011</b> |
| <b>Microfractor</b><br>WL 65mm 45° |  | Curved 45° |       | <b>891644511</b> |
| <b>Microfractor</b><br>WL 65mm 60° |  | Curved 60° |       | <b>891646011</b> |



# Instruments for Endoscopically Assisted Decompression of the Ulnar Nerve

Optical dissector / telescope

|  |                    |
|--|--------------------|
|  |                    |
|  | <b>WL</b>          |
|  | <b>Product no.</b> |
| <b>Opt. dissector WL 158mm graduated</b>   | <b>158 mm</b>      |
|  | <b>891607001</b>   |

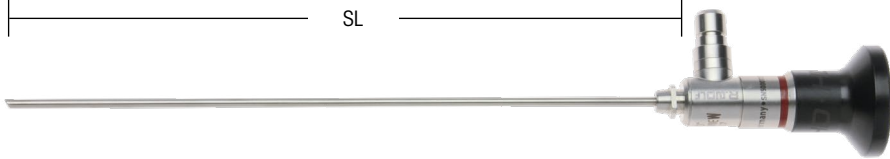
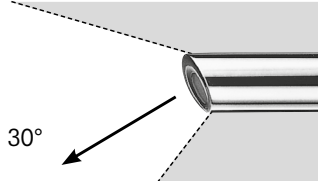
|  |  |               |               |                    |
|--|--|---------------|---------------|--------------------|
|  |  |               |               |                    |
| <b>AUTOCLAVE<br/>134° C / 273° F</b>   |  |               |               |                    |
| <b>Direction of view</b>   |  | <b>SL</b>     | <b>Ø</b>      | <b>Product no.</b> |
|   | <b>PANOVIEW<br/>telescope 30° Ø 4mm SL 170mm</b> | <b>170 mm</b> | <b>4.0 mm</b> | <b>8880.543</b>    |

|   |                              |                    |
|---|------------------------------|--------------------|
| <b>Recommended accessories</b>  |                              | <b>Product no.</b> |
| <b>Perf. basket for standard telescope 1</b>  | (L x B x H) 297 x 59 x 54 mm | <b>38015</b>       |
| <b>Fiber light cable bndl</b><br>Comprising:<br>Fiber light cable (80663523),<br>adapter, projector to light cable (8095.07), and<br>adapter, light cable to endoscope (809509) | Ø 3.5 mm, 2.3 m long         | <b>806635231</b>   |

VI121 || Subject to modifications. Please note that some products may not be available in all countries. For more detailed information, please consult with your contact partner or directly with Richard Wolf GmbH.

# Instruments for Endoscopically Assisted Decompression of the Ulnar Nerve

## Speculum



|   | WL    | Product no.      |
|---|-------|------------------|
| <b>Speculum w. Removable light rod WL 55 mm</b><br>comprising:<br>Speculum WL 55mm (8916070021) and<br>light rod (8916070022) | 55 mm | <b>891607002</b> |



**Hand / Fingers / Toes**

## Hand / Fingers / Toes

5.1

---

**Arthrolution Arthroscopes Overview**

---

5.2

**Telescopes and Sheaths**

---

5.3

**Punches / Forceps / Instruments for Small Joints**

---

5.4

**ENDO-CARTRIS – Instruments for Carpal Tunnel Release**

---

**arthro**  
*lution* Arthroscope

Overview

| arthro<br><i>lution</i> |  |                               | Fingers, toes    | Hand             | Foot, elbow      |                  | Knee, shoulder, hip |
|-------------------------|--|-------------------------------|------------------|------------------|------------------|------------------|---------------------|
| Telescope Ø             |  |                               | 1.9 mm           | 2.4 mm           | 2.7 mm           |                  | 4.0 mm              |
| Telescopes              | 30°  | PANOVIEW telescope            | <b>8860453</b>   | <b>8871413</b>   | <b>8476.433</b>  | <b>8672.422</b>  | <b>8880.543</b>     |
|                         |  | PANOVIEW wide angle telescope |                  |                  |                  |                  | <b>8885.443</b>     |
|                         | 70°  | PANOVIEW telescope            |                  |                  |                  |                  | <b>8880.545</b>     |
|                         |  | PANOVIEW wide angle telescope |                  |                  |                  |                  | <b>8885.445</b>     |
| Sheath WL               |  |                               | 40 mm            | 60 mm            | 77.5 mm          | 145 mm           | 130 mm              |
| Sheaths                 | with 1 irrigation stopcock, fixed                    |                               | <b>891220124</b> | <b>891220132</b> |                  |                  |                     |
|                         | with 2 irrigation stopcocks, fixed                   |                               |                  |                  |                  |                  | <b>89121.0260</b>   |
|                         | with 1 irrigation stopcock, rotatable                |                               |                  |                  |                  | <b>891241141</b> |                     |
|                         | with 2 irrigation stopcocks, rotatable               |                               |                  | <b>891221232</b> | <b>891221241</b> | <b>891241241</b> | <b>89121.1260</b>   |
|                         | High-Flow with 1 irrigation stopcock, fixed          |                               | <b>891220128</b> |                  |                  |                  |                     |
|                         | High-Flow with 2 irrigation stopcocks, rotatable     |                               |                  | <b>891221235</b> |                  |                  | <b>89121.1263</b>   |
|                         | Small-caliber with 2 irrigation stopcocks, rotatable |                               |                  |                  |                  |                  | <b>891221255</b>    |
| Obturator               | blunt  |                               |                  |                  | <b>891222754</b> |                  | <b>89121.0544</b>   |
|                         | semi-blunt   |                               | <b>891221952</b> | <b>891222452</b> |                  |                  | <b>89121.0542</b>   |
|                         | conical blunt  |                               |                  |                  | <b>891222750</b> | <b>891242750</b> | <b>89121.0540</b>   |
|                         | sharp  |                               |                  |                  |                  | <b>891242761</b> | <b>89121.0640</b>   |
|                         | conical pointed                                      |                               | <b>891221962</b> | <b>891222462</b> | <b>891222762</b> |                  |                     |
| Sealing part for sheath |  |                               |                  |                  |                  | <b>891040000</b> |                     |

Hand  
5.1

|| Subject to modifications. Please note that some products may not be available in all countries. For more detailed information, please consult with your contact partner or directly with Richard Wolf GmbH.

## Telescope 1.9 mm / 2.4 mm for Standard Arthroscope





**AUTOCLAVE**  
**134° C / 273° F**

| Direction of view  |   | SL    | Ø      | Product no.    |
|--|---|-------|--------|----------------|
| <br>30°  | PANOVIEW<br>telescope 30° Ø 1.9mm SL 61mm | 61 mm | 1.9 mm | <b>8860453</b> |
| <br>30° | PANOVIEW<br>telescope Ø 2.4mm SL 98mm     | 98 mm | 2.4 mm | <b>8871413</b> |

| Recommended accessories   |                              | Product no.      |
|---|------------------------------|------------------|
| <b>Perf. basket for standard telescope 1</b>  | (L x B x H) 297 x 59 x 54 mm | <b>38015</b>     |
| <b>Fiber light cable bndl</b><br>Comprising:<br>Fiber light cable (80663523),<br>adapter, projector to light cable (8095.07), and<br>adapter, light cable to endoscope (809509) | Ø 3.5 mm, 2.3 m long         | <b>806635231</b> |

**arthro** *lution* Sheath for Arthroscope

with automatic click-lock mechanism

|  |                  |         |       |                  |  |  |
|---|------------------|---------|-------|------------------|---|---|
| <b>Sheath for arthroscope OD 2.4 mm (telescope Ø 8860453)</b>                     |                  |         |       |                  | <b>Obturator for arthroscope OD 2.4/2.8 mm semi-blunt</b>                           | <b>Obturator for arthroscope OD 2.4/2.8 mm conical pointed</b>                      |
| High-Flow   | 1 fixed stopcock | Outer Ø | WL    | Product no.      |   |   |
|   | ●                | 2.4 mm  | 40 mm | <b>891220124</b> | <b>891221952</b>  | <b>891221962</b>  |
| ●   | ●                | 2.8 mm  |       | <b>891220128</b> |   |   |

Hand  
5.2



| <b>Spare parts</b>                           |   | <b>Product no.</b> |
|--|---|--------------------|
| <b>Irrigation ring with 1 stopcock</b>       |   | <b>150081761</b>   |
| <b>Stopcock bndl cap 3.0mm (PACK= 5 PCS)</b> |   | <b>896.0002</b>    |
| Also: <b>Disassembly tool</b>                |   | <b>38310.0001</b>  |
| <b>Mounting ring</b>                         |   | <b>15008.1704</b>  |
| <b>Spare seal set (O-rings)</b>              | Comprising:<br>O-ring, small (PACK= 5 PCS)<br>O-ring, large (PACK= 5 PCS) | <b>15176.142</b>   |
| Also: <b>Disassembly tool</b>                |   | <b>15106.230</b>   |

VI121 || Subject to modifications. Please note that some products may not be available in all countries. For more detailed information, please consult with your contact partner or directly with Richard Wolf GmbH.

**arthro** *lution* Sheath for Arthroscope

with automatic click-lock mechanism

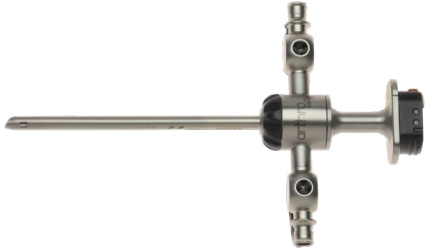



Hand  
5.2



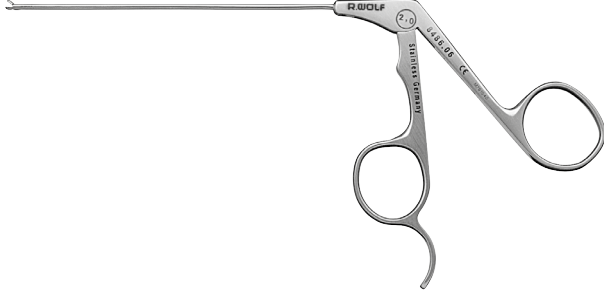

|  |                  |                       |         |       |                  |  |  |
|---|------------------|-----------------------|---------|-------|------------------|---|---|
| <b>Sheath for arthroscope OD 3.2 / 3.5 mm (telescope Ø 8871413)</b>               |                  |                       |         |       |                  | <b>Obturator for arthroscope OD 3.2/3.5 mm semi-blunt</b>                           | <b>Obturator for arthroscope OD 3.2/3.5 mm conical pointed</b>                      |
| High-Flow   | 1 fixed stopcock | 2 rotatable stopcocks | Outer Ø | WL    | Product no.      |   |   |
|   | ●                |                       | 3.2 mm  | 60 mm | <b>891220132</b> |   |   |
|   |                  | ●                     |         |       | <b>891221232</b> | <b>891222452</b>  | <b>891222462</b>  |
| ●   |                  | ●                     | 3.5 mm  |       | <b>891221235</b> |   |   |

| Spare parts                           |   | Product no.       |
|---------------------------------------|---|-------------------|
| Irrigation ring with 1 stopcock       |   | <b>150081761</b>  |
| Irrigation ring with 2 stopcocks      |   | <b>150081762</b>  |
| Stopcock bndl cap 3.0mm (PACK= 5 PCS) |   | <b>896.0002</b>   |
| Also: Disassembly tool                |   | <b>38310.0001</b> |
| Mounting ring                         |   | <b>15008.1704</b> |
| Spare seal set (O-rings)              | Comprising:<br>O-ring, small (PACK= 5 PCS)<br>O-ring, large (PACK= 5 PCS) | <b>15176.142</b>  |
| Also: Disassembly tool                |   | <b>15106.230</b>  |



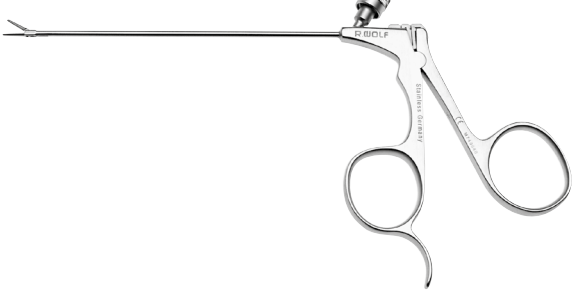



## Miniature Punch / Forceps

|  |   | Ø      | WL    | Product no.     |
|--|---|--------|-------|-----------------|
|  |   |        |       |                 |
| <b>Hook punch</b><br>Ø 2 mm  |    | 2.0 mm | 65 mm | <b>8486.601</b> |
| <b>Miniature punch</b><br>Ø 2.2 mm   |   | 2.2 mm | 75 mm | <b>8486.602</b> |
| <b>Miniature forceps</b><br>Ø 2 mm<br>with double spoon jaw                        |  | 2.0 mm | 60 mm | <b>8486.611</b> |
| <b>Miniature grasping forceps</b><br>Ø 2 mm  |  | 2.0 mm | 60 mm | <b>8486.621</b> |

|  |   | Sheath Ø | WL     | Product no.     |
|--|---|----------|--------|-----------------|
|  |   |          |        |                 |
| <b>Miniature forceps</b><br>Ø 2.7mm<br>with double spoon jaw                         |  | 2.7 mm   | 110 mm | <b>8486.614</b> |
| <b>Miniature grasping forceps</b><br>Ø 2.7mm   |  |          |        | <b>8486.624</b> |
| <b>Hook punch</b><br>Ø 2.7mm   |  |          |        | <b>8486.604</b> |

## Instruments for Small Joints

|   |            |        |                 |
|---|------------|--------|-----------------|
|   | ∅          | WL     | Product no.     |
| <b>Spoon ∅ 2.4x1mm WL 100mm</b><br>              | 2.4 x 1 mm | 100 mm | <b>8871.562</b> |
| <b>Curette round ∅ 1.45mm WL 100mm</b><br>     | 1.45 mm    |        | <b>8871.571</b> |
| <b>Knife with handle WL 100mm</b><br>          | --         |        | <b>8871.586</b> |
| <b>Hook probe WL 100mm H2mm</b><br>H = 2.0 mm  | --         |        | <b>8871.721</b> |



**FLUID CONTROL**  
**Irrigation and Suction Pumps**

## FLUID CONTROL Irrigation and Suction Pump

6.1

---

### FLUID CONTROL Arthro 2204

---

VII/21 II - Subject to modifications. Please note that some products may not be available in all countries. For more detailed information, please consult with your contact partner or directly with Richard Wolf GmbH.

## FLUID CONTROL Arthro 2204

Suction and irrigation pump for arthroscopy  
with automatic tube recognition



### FLUID CONTROL Arthro

is a new pump system for arthroscopy and fully endoscopic spinal surgery. The particular strength of this system lies in a practical combination of high performance and a cost-effective overall concept. The new software and technical enhancements make the **FLUID CONTROL Arthro** ideal for diagnostic and therapeutic arthroscopies.

**FLUID CONTROL Arthro** has already been prepared for integration in core, the digital OR from Richard Wolf.

## FLUID CONTROL Arthro 2204

Suction and irrigation pump for arthroscopy  
with automatic tube recognition



### Arthro/spine suc./irrig.pump bndl

for arthroscopy ..... **22040011**

Comprising:

- 1 x arthro/spine suc./irrig.pump 200mmHG ..... 2204001
- 1 x irrigation tube set spike ..... 8171223
- 1 x tube set for vacuum, incl. filter ..... 2206207
- 1 x protection filter for gas filtration ..... 4171.121
- 1 x power cable ..... 2440.03

### Arthro/spine suc./irrig.pump bndl

with Spine Mode software module for arthroscopy and  
fully endoscopic spinal surgery ..... **22040012**

Comprising:

- 1 x arthro/spine suc./irrig.pump 200mmHG ..... 2204001
- 1 x Spine mode software module .....2204101
- 1 x irrigation tube set spike ..... 8171223
- 1 x tube set for vacuum, incl. filter ..... 2206207
- 1 x protection filter for gas filtration ..... 4171.121
- 1 x power cable ..... 2440.03

| Recommended accessories |   | Product no.    |
|-------------------------|---|----------------|
| Footswitch              |  | <b>2204901</b> |

# FLUID CONTROL Arthro 2204

## Irrigation and suction pump for arthroscopy with automatic tube recognition

### Day-patient tube set

#### From two interventions/patients per day:

Use the **day-patient tube set**, which comprises a day tube and a connected patient tube. The day tube remains in the pump throughout the day, while the patient tube has to be changed for each operation. The irrigation fluid bag can remain on the pump until it has been comple-

tely used up. **This significantly reduces the amount of waste and cuts costs.**

**Further tube versions are available to complement the system.**

**Note:** The use of the day-patient tube set has not been approved for the Spine Mode application.

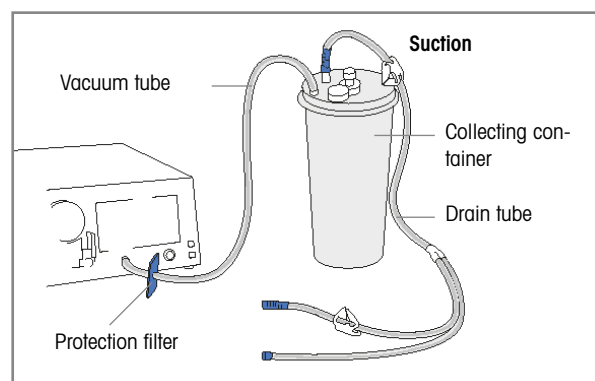
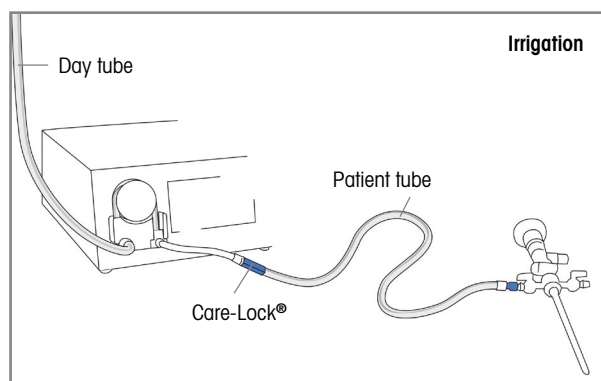

| Irrigation  |                                      |  | Product no. |
|---|--------------------------------------|--|-------------|
| Accessories – reusable  | Irrigation tube set spike            | With Luer-Lock connection, autoclavable, incl. 10 spare membranes, reusable for 20 reprocessing cycles | 8171223     |
|   | Irrigation tube set with spike L 3 m | (PACK= 10 PCS), with Luer-Lock connection, sterile, disposable product                                 | 4171223     |
| Accessories – disposable  | Irrigation tube set CARE-LOCK, L 3 m | (PACK= 10 PCS), sterile, disposable product  | 4171224     |
|   | Day irrigation tube set              | (PACK= 10 PCS), with piercing spike, sterile disposable product, PVC                                   | 4171226     |
|   | Patient irrigation tube set L 3m     | (PACK= 10 PCS), with Luer-Lock connection, sterile, disposable product, PVC                            | 4171227     |
| <i>Note: Day tube and patient tube can only be used together. A new patient tube is required for each patient – the day tube can be used for up to 20 patients.</i> |                                      |  |             |

| Suction                  |                                     |  | Product no. |
|--------------------------|-------------------------------------|--|-------------|
| Accessories – reusable   | Tube set for vacuum, incl. filter   | with integrated hygiene filter, PACK= 10 PCS, service life of 30 days (connected to irrigation pump) | 2206207     |
| Accessories – disposable | Secretion container, 2 L            | 2 liters, no lid   | 8170.6551   |
|                          | Secretion container, 2.5 L          | 2.5 liters (PACK= 2 PCS)   | 41706566    |
|                          | Tube set for suction (with 2 ports) | sterile, disposable, (PACK= 10 PCS) for connecting instruments to collecting container               | T0503-01    |

VII/21 || Subject to modifications. Please note that some products may not be available in all countries. For more detailed information, please consult with your contact partner or directly with Richard Wolf GmbH.

## Technical Data

### FLUID CONTROL Arthro 2204

| <b>Arthro/spine suc./irrig.pump 200mmHG</b>            | <b>2204001</b>                         |
|--|--|
| Power supply connection                                | 100–240 VAC, 50/60 Hz                  |
| Power consumption                                      | 118 VA                                 |
| Protection class to VDE 0750 / IEC 601                 | 1                                      |
| Classification   | CF                                     |
| Pressure range (infinite preselection)                 | 15–200 mmHg                            |
| Delivery rate (can be preselected in 50 ml increments) | 0–2 l/min                              |
| Dimensions (W x H x D)                                 | 300 x 157 x 436 mm                     |
| Weight   | 8.3 kg                                 |
| Interfaces   | USB / CAN bus (core) service interface |





## Universal Motor Systems

## Universal Motor Systems

7.1

---

**PowerSpeed AS1** Universal Motor System

---

7.2

**Power Stick M5/3 and M5/0** Motor Handpieces for PowerSpeed AS1

---

7.3

**Reusable Shaver Blades and Burrs**

for Power Stick M5/3, Power Stick M5/0, and Micro Stick S1

---

7.4

**Disposable Shaver Blades and Burrs**

for Power Stick M5/3, Power Stick M5/0, and Micro Stick S1

---

# PowerSpeed AS1

## Universal motor system



**The PowerSpeed AS1 motor system has been developed for universal use and provides extremely comfortable and ergonomic handling.**

**Quick and powerful resecting, drilling, burring, or sawing – anything is possible.**

- Wide range of disposable and reusable shaver blades and burrs
- Intelligent tool detection via RFID chip
- Touchscreen makes user interface easy to operate
- Communication interface with FLUID CONTROL ArthroPump 2204 and **core nova**
- Universal use of all current Richard Wolf motor handpieces
- Wireless footswitch
- Universal use in spinal surgery, bronchoscopy, and arthroscopy

# PowerSpeed AS1

## Universal motor system

Motor Systems  
7.1



### MOTOR CONTROL UNIT 2305

Power supply connection 50/60 Hz, 100–240 V

includes power supply cable,

CAN bus connection cable, and packaging ..... **2305001**

Universal motor system for orthopedics and spinal surgery, for connecting motor handpieces when working with shaver and high-speed applications, and for connecting the Power Drill M1.

| Recommended accessories              |   | Product no.       |
|--------------------------------------|---|-------------------|
| Remote footswitch 2 pedals+2 buttons |  | <b>2305100</b>    |
| Also:                                |   |                   |
| Power supply unit 6600403            |   | <b>FW8002M/08</b> |
| Backup cable, WL 3m                  |   | <b>2305300</b>    |

VII.21 || Subject to modifications. Please note that some products may not be available in all countries. For more detailed information, please consult with your contact partner or directly with Richard Wolf GmbH.

## Technical Data

### PowerSpeed AS1

| MOTOR CONTROL UNIT 2305   | 2305001   |
|---|---|
| Power supply connection   | 100–240 VAC, 50/60 Hz   |
| Power consumption   | 250 VA  |
| Electromagnetic compatibility EMC to  | IEC / EN 60601-1-2  |
| Medical Devices Directive 93/42/EEC   | Class IIa   |
| Protection class to IEC / EN 60601-1<br>(ANSI / AAMI ES60601-1 / CAN CSA-C22.2 No. 60601-1) | I   |
| Protection against electric shock   | Type BF applied part  |
| Degree of protection against the ingress of liquids   | IP 20 (not protected)   |
| Operating mode  | Continuous operation  |
| Degree of protection in the presence of flammable mixtures                                  | Device is not protected against explosions<br>(do not operate device in areas where there is a danger of explosion) |
| Weight  | 9.2 kg  |
| Dimensions (W x H x D)  | 300 x 159.5 x 404 mm  |

## Power Stick M5/3

## Power Stick M5/0

### Motor Handpieces for PowerSpeed AS1

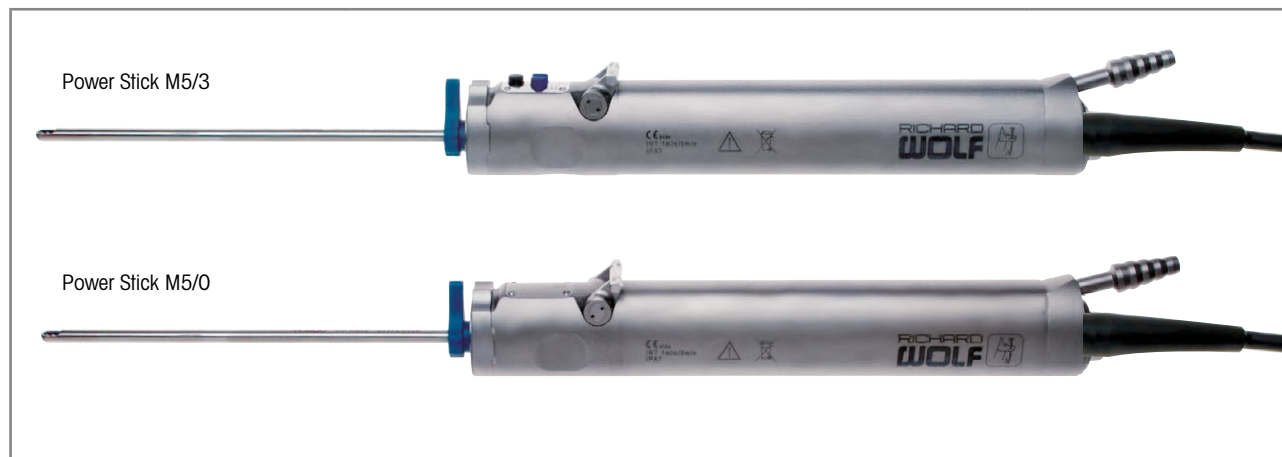

| For driving rotation tools with three function buttons    |  |  | Ø for shaver tools | Product no.       |
|---|--|--|--------------------|-------------------|
| Power Stick M5/3<br><b>Motor handpiece max. 16000 rpm</b> | with fixed connection cable, 3.0 m     | Operated via button cluster and footswitch | 2–6.5 mm           | <b>8995500031</b> |
|   | with removable connection cable, 3.0 m |  |                    | <b>89955.0003</b> |
| For driving rotation tools                                |  |  | Ø for shaver tools | Product no.       |
| Power Stick M5/0<br><b>Motor handpiece max. 16000 rpm</b> | with fixed connection cable, 3.0 m     | Operated via footswitch                    | 2–6.5 mm           | <b>8995500001</b> |
|   | with removable connection cable, 3.0 m |  |                    | <b>89955.0000</b> |

- Handpieces with/without control panel
- Up to 16,000 rpm
- For tools with a diameter of 2.5–6.5 mm
- Oscillation frequency of up to 4 Hz

| Recommended accessories        |   | Product no.     |
|--------------------------------|---|-----------------|
| Connection cable, WL 3m        | 3.0 m long  | <b>8564.851</b> |
| Container (wxhxd) 400x60x200mm | Holds: Instruments, for sterilization (steam and low-temperature), storage and transport, with instrument mat, inner dimensions (wxhxd): 400x57x200mm, outer dimensions (BxHxT): 466x77x266mm | <b>33022</b>    |

# Micro Stick S1

Motor handpiece for PowerSpeed AS1

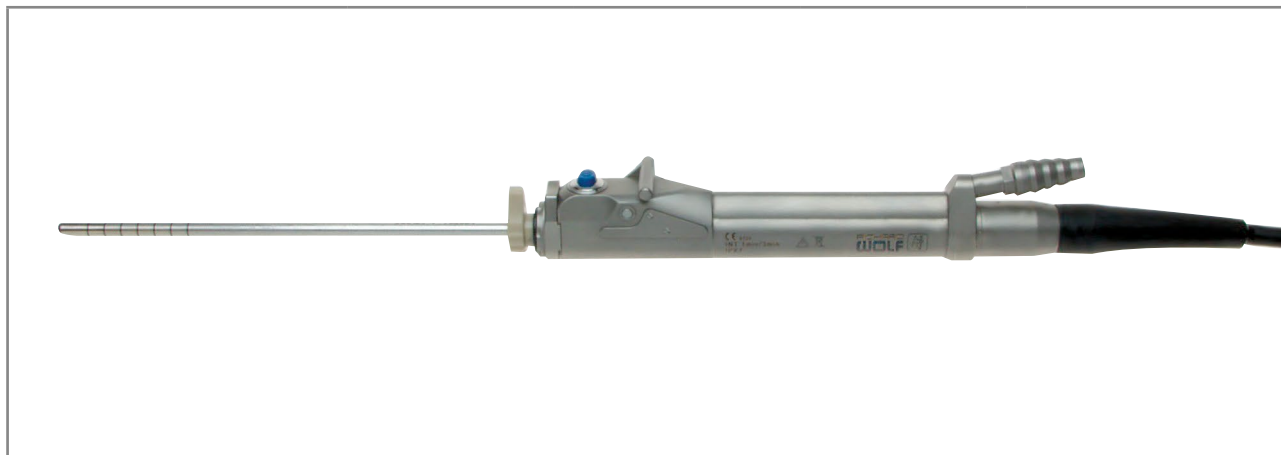

| For driving rotation tools with one function button |                                    |                                | Ø for shaver tools | Product no. |
|---|------------------------------------|--------------------------------|--------------------|-------------|
| Motor handpiece max. 3000 rpm                       | with fixed connection cable, 3.0 m | Operated via the ON/OFF button | 2–3.5 mm           | 899510001   |





- Mini motor handpiece for exceptional precision in small joints
- Up to 3,000 rpm
- Practical range of accessories
- For shaver tools with a diameter of 2–3.5 mm

| Recommended accessories               |   | Product no.  |
|---------------------------------------|---|--------------|
| <b>Container (wxhxd) 400x60x200mm</b> | Holds: Instruments, for sterilization (steam and low-temperature), storage and transport, with instrument mat, inner dimensions (wxhxd): 400x57x200mm, outer dimensions (BxHxT): 466x77x266mm | <b>33022</b> |

## Reusable Shaver Blades and Burrs

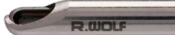
for Power Stick M5/3 and M5/0 motor handpiece,  
large interface









|   | Reusable<br>(1 PC)        | Color coding  | WL     | ∅       | Product no.       |
|---|---------------------------|---------------|--------|---------|-------------------|
|  | Resector smooth ∅ 3.5mm   | canary yellow | 130 mm | 3.5 mm  | <b>899750003</b>  |
|   | Resector smooth ∅ 4.5mm   |               |        | 4.5 mm  | <b>899750004</b>  |
|   | Resector smooth ∅ 5.5mm   |               |        | 5.5 mm  | <b>899750005</b>  |
|  | Resector toothed ∅ 2mm    | ocher         | 45 mm  | 2.0 mm  | <b>89975.0032</b> |
|   | Resector toothed ∅ 2.7mm  |               | 80 mm  | 2.7 mm  | <b>899750132</b>  |
|   | Resector toothed ∅ 3.5mm  |               | 130 mm | 3.5 mm  | <b>89975.0033</b> |
|   | Resector toothed ∅ 4.5mm  |               |        | 4.5 mm  | <b>89975.0034</b> |
|   | Resector toothed ∅ 5.5mm  |               |        | 5.5 mm  | <b>89975.0035</b> |
|  | Resector aggress ∅ 2.7mm  | red           | 80 mm  | 2.7 mm  | <b>899750332</b>  |
|   | Resector aggress ∅ 3.7mm  |               | 130 mm | 3.7 mm  | <b>89975.0333</b> |
|   | Resector aggress ∅ 4.7mm  |               |        | 4.7 mm  | <b>89975.0334</b> |
|   | Resector aggress ∅ 5.85mm |               |        | 5.85 mm | <b>899750335</b>  |
|  | Resector oval ∅ 3.5mm     | white         | 130 mm | 3.5 mm  | <b>89975.0113</b> |
|   | Resector oval ∅ 4.5mm     |               |        | 4.5 mm  | <b>89975.0114</b> |
|   | Resector oval ∅ 5.5mm     |               |        | 5.5 mm  | <b>89775.0115</b> |



## Reusable Shaver Blades and Burrs

for Power Stick M5/3 and M5/0 motor handpiece,  
large interface



|  | Reusable<br>(1 PC)                        | Color coding  | WL     | Ø      | Product no.       |
|--|---|---------------|--------|--------|-------------------|
|                              | Resector convex curved smooth<br>Ø 3.5mm  | canary yellow | 130 mm | 3.5 mm | <b>89975.0253</b> |
|  | Resector convex curved smooth<br>Ø 4.5mm  |               |        | 4.5 mm | <b>89975.0254</b> |
|                             | Resector concave curved smooth<br>Ø 3.5mm | canary yellow | 130 mm | 3.5 mm | <b>89975.0263</b> |
|  | Resector concave curved smooth<br>Ø 4.5mm |               |        | 4.5 mm | <b>89975.0264</b> |
|                             | End cutter Ø 3.5mm                        | black         | 130 mm | 3.5 mm | <b>89975.0493</b> |
|  | End cutter Ø 4.5mm                        |               |        | 4.5 mm | <b>89975.0494</b> |
| <br>with lateral protection | Burr round Ø 3mm                          | gulf blue     | 80 mm  | 3.0 mm | <b>89975.0503</b> |
|  | Burr round Ø 4.5mm                        |               | 130 mm | 4.5 mm | <b>89975.0504</b> |
|  | Burr round Ø 5.5mm                        |               |        | 5.5 mm | <b>89975.0505</b> |
| <br>no hood                 | Burr round Ø 6mm                          | royal blue    | 130 mm | 6.0 mm | <b>89975.0516</b> |
| <br>with lateral protection | Acromionizer Ø 3.5mm                      | purple        | 130 mm | 3.5 mm | <b>89975.0553</b> |
|  | Acromionizer Ø 4.5mm                      |               |        | 4.5 mm | <b>89975.0554</b> |
|  | Acromionizer Ø 5.5mm                      |               |        | 5.5 mm | <b>89975.0555</b> |
|  | Acromionizer Ø 6.5mm                      |               |        | 6.5 mm | <b>89975.0556</b> |

## Reusable Shaver Blades and Burrs

for Power Stick M5/3 and M5/0 motor handpiece  
for hip arthroscopy



|  | Reusable<br>(1 PC)                        | Color coding | WL     | Ø      | Product no.       |
|--|---|--------------|--------|--------|-------------------|
|    | Resector toothed Ø 4.7mm                  | ocher        | 200 mm | 4.7 mm | <b>899732004*</b> |
|   | Resector aggress Ø 4.7mm                  | red          | 200 mm | 4.7 mm | <b>899732334*</b> |
|   | Resector convex curved<br>aggress Ø 4.7mm | red          | 200 mm | 4.7 mm | <b>899732254</b>  |
|   | Resector convex curved<br>aggress Ø 4.7mm | red          | 200 mm | 4.7 mm | <b>899732264</b>  |
| <br>with 2 mm retracted<br>lateral protection | Burr round Ø 5.5mm                        | gulf blue    | 200 mm | 5.5 mm | <b>899732504</b>  |
| <br>with 2 mm retracted<br>lateral protection | Acromionizer Ø 5.5mm                      | purple       | 200 mm | 5.5 mm | <b>899732555</b>  |

\* Shaver blade with distal guide hole for guide wire Ø 2.0 mm

## Reusable Shaver Blades and Burrs

for Micro Stick S1,  
small interface

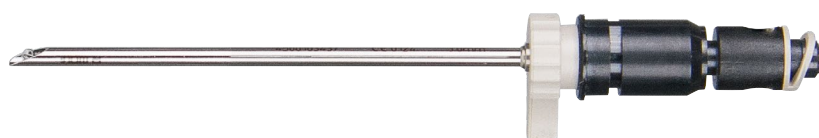

|  | Reusable<br>(1 pc)                        | Color coding  | WL     | Ø      | Product no.       |
|--|---|---------------|--------|--------|-------------------|
|                             | Resector toothed Ø 2mm                    | ocher         | 45 mm  | 2.0 mm | <b>89971.0032</b> |
|  | Resector toothed Ø 3.5mm                  |               | 130 mm | 3.5 mm | <b>89971.0033</b> |
|  | Resector toothed Ø 4.5mm                  |               |        | 4.5 mm | <b>89971.0034</b> |
|  | Resector toothed Ø 2.5mm                  |               | 80 mm  | 2.5 mm | <b>899710132</b>  |
|                             | Resector aggress Ø 2.7mm                  | red           | 80 mm  | 2.7 mm | <b>899710332</b>  |
|                             | Resector oval Ø 3.5mm                     | white         | 130 mm | 3.5 mm | <b>89971.0113</b> |
|  | Resector oval Ø 4.5mm                     |               |        | 4.5 mm | <b>89971.0114</b> |
|                             | Resector convex curved smooth<br>Ø 4.5mm  | canary yellow | 130 mm | 4.5 mm | <b>89971.0254</b> |
|                             | Resector concave curved smooth<br>Ø 4.5mm | canary yellow | 130 mm | 4.5 mm | <b>89971.0264</b> |
| <br>with lateral protection | Burr round Ø 3mm                          | gulf blue     | 80     | 3.0 mm | <b>89971.0503</b> |

## Disposable Shaver Blades and Burrs

for Power Stick M5/3 and M5/0 motor handpiece



|   | Disposable<br>(5 PCS, in individual sterile<br>packaging) | Color coding  | WL     | Ø      | Product no.       |
|---|---|---------------|--------|--------|-------------------|
|  | Resector smooth Ø 3.5mm                                   | canary yellow | 130 mm | 3.5 mm | <b>49975.0003</b> |
|   | Resector smooth Ø 4.5mm                                   |               |        | 4.5 mm | <b>49975.0004</b> |
|   | Resector smooth Ø 5.5mm                                   |               |        | 5.5 mm | <b>49975.0005</b> |
|  | Resector toothed Ø 3.5mm                                  | ocher         | 130 mm | 3.5 mm | <b>49975.0033</b> |
|   | Resector toothed Ø 4.5mm                                  |               |        | 4.5 mm | <b>49975.0034</b> |
|   | Resector toothed Ø 5.5mm                                  |               |        | 5.5 mm | <b>49975.0035</b> |
|  | Resector aggress Ø 2.5mm                                  | red           | 80 mm  | 2.5 mm | <b>499750332</b>  |
|   | Resector aggress Ø 3.5mm                                  |               | 130 mm | 3.5 mm | <b>49975.0333</b> |
|   | Resector aggress Ø 4.5mm                                  |               |        | 4.5 mm | <b>49975.0334</b> |
|   | Resector aggress Ø 5.5mm                                  |               |        | 5.5 mm | <b>49975.0335</b> |
|  | Resector oval Ø 3.5mm                                     | white         | 130 mm | 3.5 mm | <b>49975.0113</b> |
|   | Resector oval Ø 4.5mm                                     |               |        | 4.5 mm | <b>49975.0114</b> |
|   | Resector oval Ø 5.5mm                                     |               |        | 5.5 mm | <b>49975.0115</b> |

## Disposable Shaver Blades and Burrs

for Power Stick M5/3 and M5/0 shaver handle





|   | Disposable<br>(5 PCS, in individual sterile<br>packaging) | Color coding  | WL     | Ø      | Product no.       |
|---|---|---------------|--------|--------|-------------------|
|                                 | Resector convex curved smooth<br>Ø 3.5mm                  | canary yellow | 130 mm | 3.5 mm | <b>49975.0253</b> |
|   | Resector convex curved smooth<br>Ø 4.5mm                  |               |        | 4.5 mm | <b>49975.0254</b> |
|   | Resector convex curved smooth<br>Ø 5.5mm                  |               |        | 5.5 mm | <b>49975.0255</b> |
|                                | Resector concave curved smooth<br>Ø 3.5mm                 | canary yellow | 130 mm | 3.5 mm | <b>49975.0263</b> |
|   | Resector concave curved smooth<br>Ø 4.5mm                 |               |        | 4.5 mm | <b>49975.0264</b> |
|   | Resector concave curved smooth<br>Ø 5.5mm                 |               |        | 5.5 mm | <b>49975.0265</b> |
|                                | End cutter Ø4.5 mm  | black         | 130 mm | 4.5 mm | <b>49975.0494</b> |
| <br>with lateral<br>protection | Burr round Ø 4.5mm  | gulf blue     | 130 mm | 4.5 mm | <b>49975.0504</b> |
| <br>no hood                    | Burr round Ø 6mm  | gulf blue     | 130 mm | 6.0 mm | <b>49975.0516</b> |
| <br>with lateral<br>protection | Acromionizer Ø 3.5mm                                      | purple        | 130 mm | 3.5 mm | <b>49975.0553</b> |
|   | Acromionizer Ø 4.5mm                                      |               |        | 4.5 mm | <b>49975.0554</b> |
|   | Acromionizer Ø 5.5mm                                      |               |        | 5.5 mm | <b>49975.0555</b> |
|   | Acromionizer Ø 6.5mm                                      |               |        | 6.5 mm | <b>49975.0556</b> |

## Disposable Shaver Blades and Burrs

for Power Stick M5/3 and M5/0 shaver handle

for hip arthroscopy



|  | Disposable<br>(5 PCS, in individual sterile<br>packaging) | Color coding | WL     | ∅      | Product no.      |
|--|---|--------------|--------|--------|------------------|
|    | <b>Resector curved universal<br/>∅ 4.5mm</b>              | gray         | 160 mm | 4.5 mm | <b>499732274</b> |
| <br>with 2 mm retracted<br>lateral protection | <b>Resector universal ∅ 4.5mm</b>                         | gray         | 160 mm | 4.5 mm | <b>499732344</b> |
| <br>with 2 mm retracted<br>lateral protection | <b>Burr oval ∅ 5.5mm</b>                                  | purple       | 160 mm | 5.5 mm | <b>499732565</b> |

## Disposable Shaver Blades and Burrs

for Micro Stick S1



|   | Disposable<br>(5 PCS, in individual sterile<br>packaging) | Color coding  | WL     | ∅      | Product no.       |
|---|---|---------------|--------|--------|-------------------|
|                                 | <b>Resector toothed ∅ 2mm</b>                             | ocher         | 45 mm  | 2.0 mm | <b>49971.0032</b> |
|   | <b>Resector toothed ∅ 3.5mm</b>                           |               | 130 mm | 3.5 mm | <b>49971.0033</b> |
|                                | <b>Resector aggress ∅ 2.5mm</b>                           | red           | 80 mm  | 2.5 mm | <b>499710332</b>  |
|                                | <b>Resector oval ∅ 3.5mm</b>                              | white         | 130 mm | 3.5 mm | <b>49971.0113</b> |
| <br>with lateral<br>protection | <b>Burr round ∅ 3mm</b>                                   | gulf blue     | 130 mm | 3.0 mm | <b>49971.0503</b> |
| <br>with lateral<br>protection | <b>Burr oval ∅ 3.5mm</b>                                  | canary yellow | 130 mm | 3.5 mm | <b>49971.0553</b> |

